

This page lists the contents included in the box. Please take time to identify the hardware as well as the individual components of the product. As you unpack and prepare for assembly, place the contents on a carpeted or padded area to protect them from damage. Please follow the assembly instructions closely. Improper assembly can result in personal or property damage.

IMPORTANT SAFETY INSTRUCTIONS:
If you are unsure about your ceiling type or what mounting method you should use, consult a qualified professional or your local hardware store.

We recommend installation of this lamp be performed by a licensed electrician.

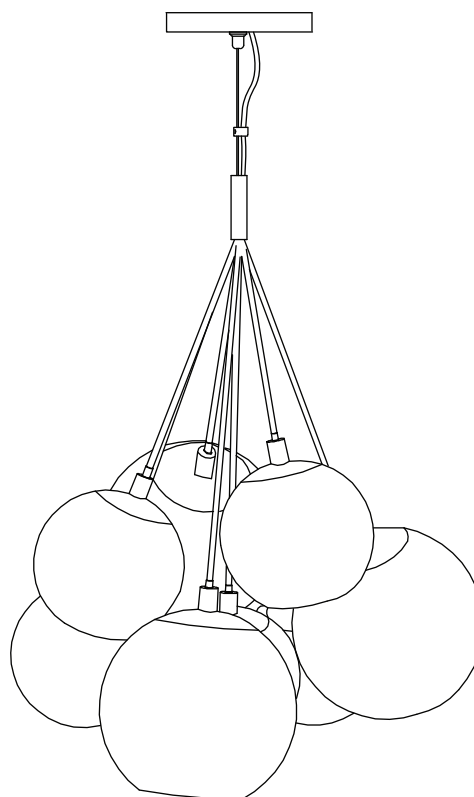
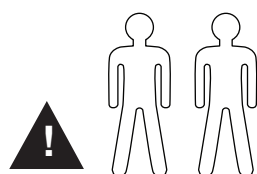

hardware & components

800.606.6387

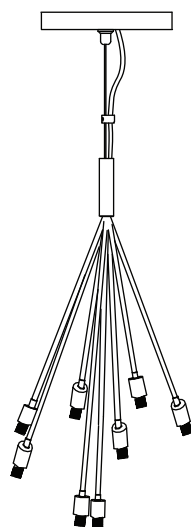

1 - lamp assembly

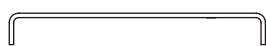

1 - mounting plate



2 - canopy bolts



3 - wire nuts



8 - shade caps

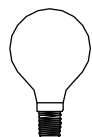

8 - 25 watt max type G bulbs (NOT INCLUDED)



8 - rubber gaskets



8 - socket rings



2 - mounting bolts

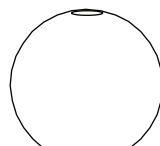

8 - shades (3 large, 5 small)

tools required



electrical tape

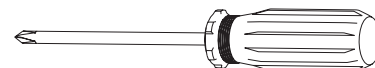

Phillips head screwdriver

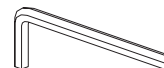

Allen wrench (included)

cleaning & care

Dust surfaces with a dry soft cloth. Do not use cleaners or polishes on the lamp.

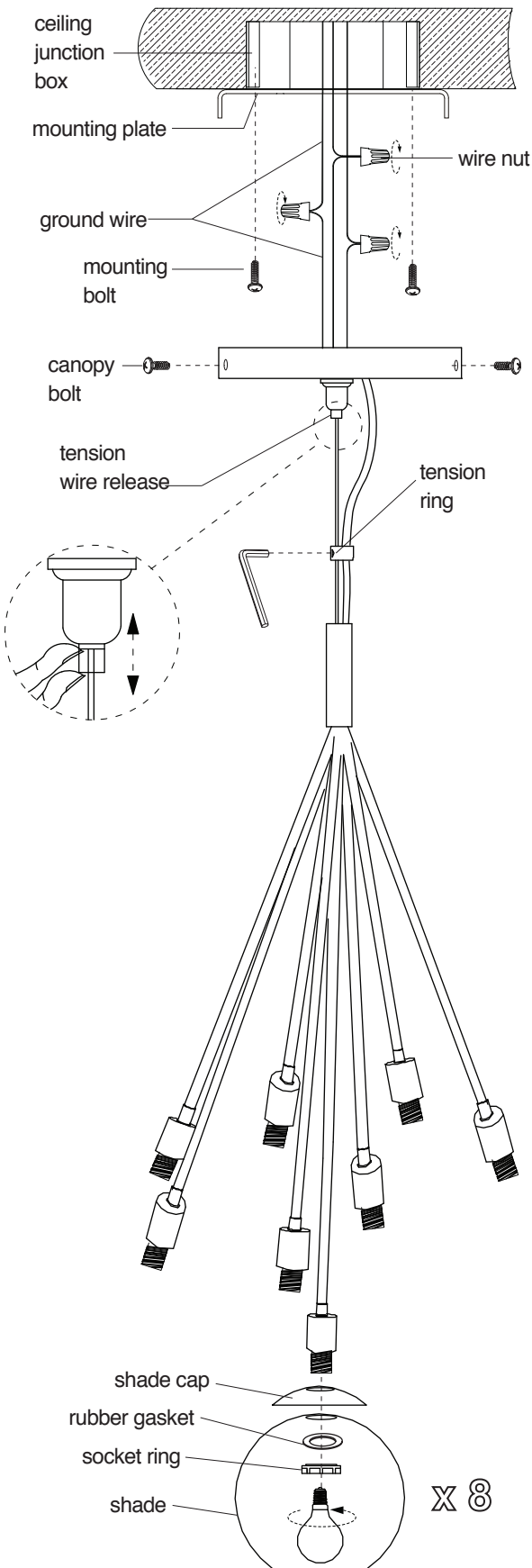

- 1) Shut off the main electrical supply from the main fuse box/circuit breaker.
- 2) Carefully unpack all fixture parts and hardware. Lay items out on a clear workspace.
- 3) Determine desired height of fixture. Push on the *tension wire release* as shown and adjust length of cord and tension wire. Release tension wire release when cord is at desired length.
- 4) Loosen set screw on the *tension ring* with the **allen wrench**. Place tension ring at desired position and retighten.
- 5) Place the **mounting plate** over the center of the ceiling junction box.
- 6) Align holes in **mounting plate** with holes in junction box and attach with 2 **mounting bolts**, using a **phillips head screwdriver**.
- 7) Gently pull wiring down from ceiling junction box and allow it to hang.
- 8) Carefully inspect the lamp fixture's wires:
 - *Neutral fixture wire* = white
 - *Hot fixture wire* = black
 - *Ground wire* = green
- 9) Attach the *ground wire* of the lamp assembly to the *ground wire* from the junction box and fasten each together with a **wire nut**. Wrap the connection with **electrical tape**.
- 10) Attach the *neutral fixture wire* from the lamp to the *neutral junction box wire* (usually white). Fasten each together with a **wire nut** and wrap the connection with **electrical tape**.
- 11) Attach the *hot fixture wire* from the lamp to the *hot junction box wire* (usually black). Fasten each together with a **wire nut** and wrap the connection with **electrical tape**.
DO NOT REVERSE THE HOT AND NEUTRAL CONNECTIONS OR SAFETY WILL BE COMPROMISED.
- 12) Gently tuck wire connections neatly into the ceiling junction box.
- 13) Fit **canopy** over **mounting plate** until it is flush to the ceiling. Align holes in canopy with holes in mounting plate and secure with 2 **canopy bolts**.
- 14) Fit **shade cap** and **shade** onto each socket assembly and secure with a **rubber washer** and **socket ring**.
- 15) Insert 1- **bulb (not included)** into each socket. DO NOT EXCEED SPECIFIED WATTAGE.
- 16) Restore power to junction box and test fixture. Installation is now complete.