

Thank you for purchasing the **Tesso Bookcase**. This page lists all the contents included in the box. Please take the time to identify the hardware as well as the individual components to this product. As you unpack and prepare for assembly, place the contents on a carpeted or padded area to protect them from damage.  
 Note: 2 people are required to safely assemble this product.

## hardware

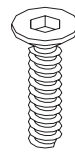

12 - bolts



6 - screws



6 - drywall anchors



2 - adjustable feet



10 - set screws



6 - spring washers

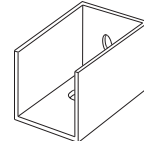

6 - connecting brackets

Missing hardware?  
 Please call **800.606.6387** for replacements.

## tools required

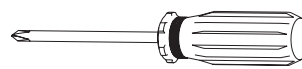

Phillips head screwdriver

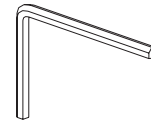

Allen wrench (included)

(We recommend the use of hand tools instead of power tools)

## components

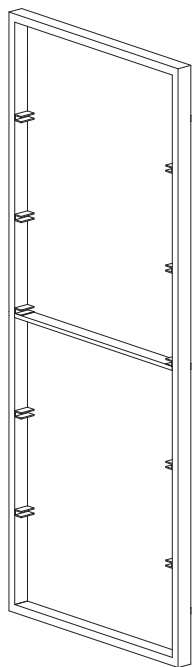

1 - frame assembly

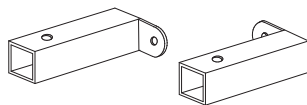

6 - brackets  
 (3 left, 3 right)

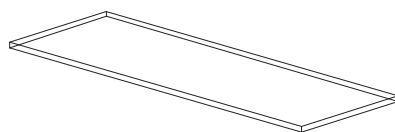

5 - glass panels

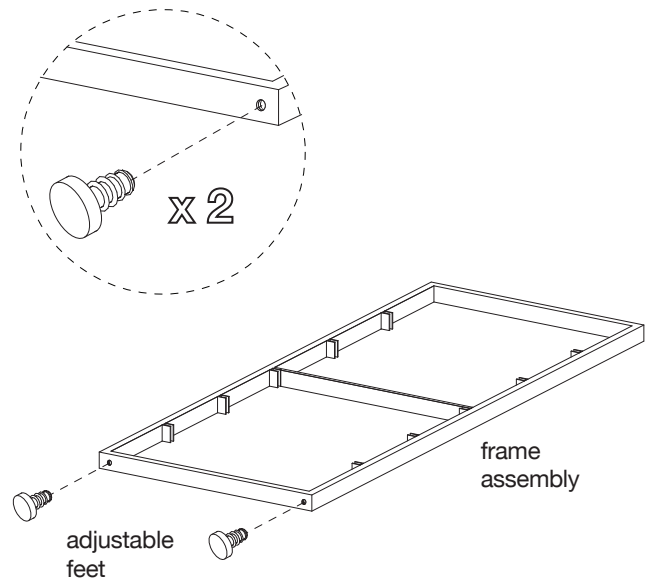

Place **frame assembly** onto a clean, padded surface. Attach 2 **adjustable feet** as shown. Turn feet clockwise to secure.

1

**NOTE:** Do not over tighten bolts

connecting bracket

frame assembly

top of frame

**NOTE:** Make sure connecting brackets face away from feet as shown

**2** Attach 6 **connecting brackets** to **frame assembly** with 6 **bolts** and 6 **spring washers** as shown. Make sure connecting brackets all face same direction as shown. Secure, but do not over tighten, bolts with an **allen wrench**.

bracket

frame assembly

**3** Fit 6 **brackets** onto connecting brackets as shown. Secure with 6 **bolts** as shown.

**NOTE:** Do not over tighten screws.

A

WALL

B

**4**

A. With the assistance of another adult, position unit upright and mark hole positions on wall. Set assembled unit aside. Insert 6 **drywall anchors** into each marked hole, using a **Phillips head screwdriver**.

B. At this point, position unit upright against wall and insert 1 **screw** through each **bracket** and **drywall anchor**. Secure, but do not over tighten, screws with a screwdriver.

A

B

X 6

**NOTE:** These instructions are for **drywall mounting only**. For safe installation it is essential to use hardware appropriate for your wall type. Mount to wood wall studs whenever possible. If you are unsure of what type of fasteners to use, consult your local hardware store or a qualified professional.

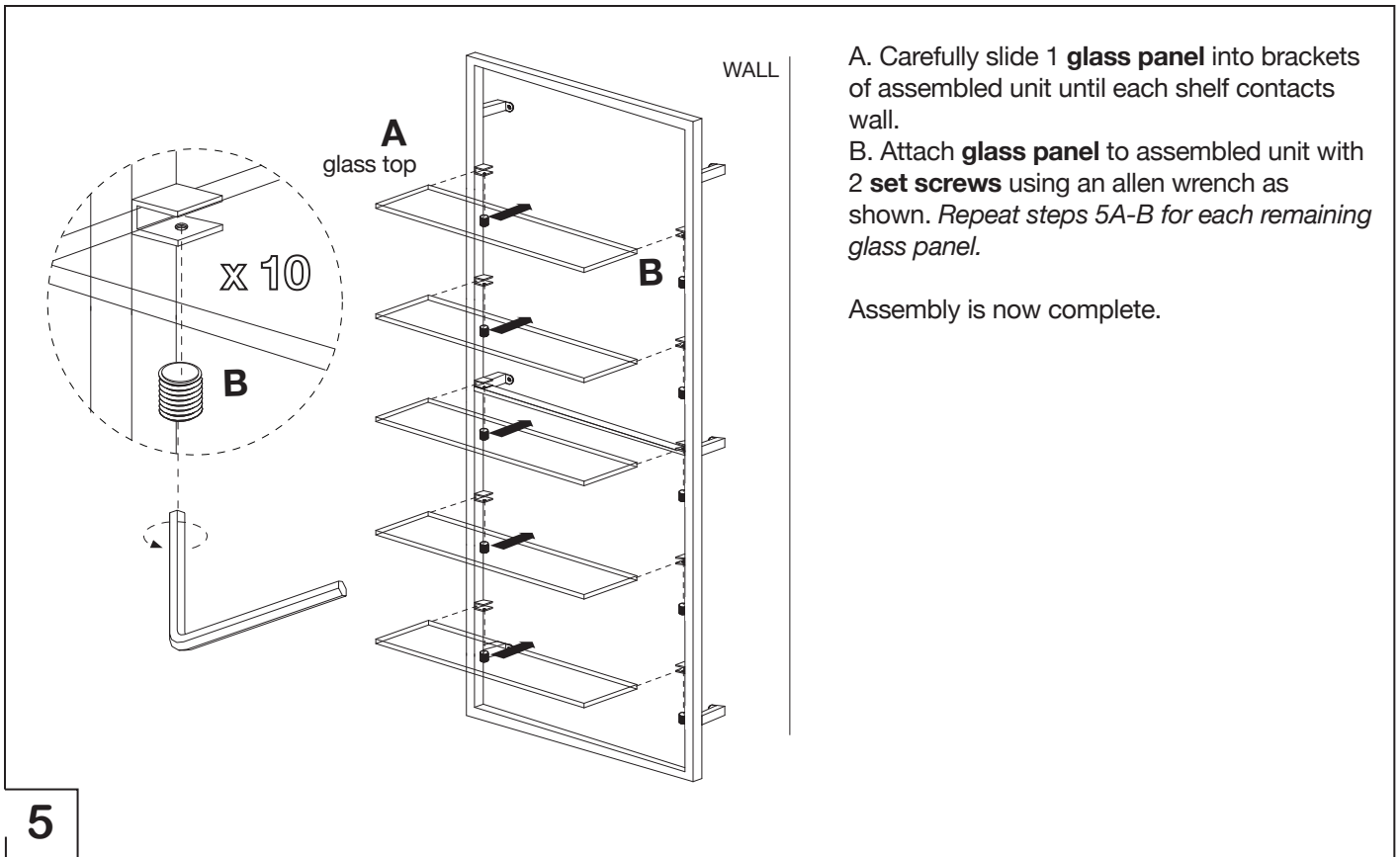

A. Carefully slide 1 **glass panel** into brackets of assembled unit until each shelf contacts wall.

B. Attach **glass panel** to assembled unit with 2 **set screws** using an allen wrench as shown. Repeat steps 5A-B for each remaining glass panel.

Assembly is now complete.

## cleaning & care

Clean surfaces with a dry or damp soft cloth. Do not use abrasive cleaners.