

Thank you for purchasing the **Strap Bench**. This page lists all the contents included in the box. Please take time to identify the hardware as well as the individual components of this product. As you unpack and prepare for assembly, place the contents on a carpeted or padded area to protect them from damage.

**NOTE:** 2 people are required to safely assemble this product.

## hardware

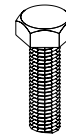

4 - hex bolts

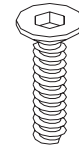

4 - allen bolts

Missing hardware? Please call **800.606.6387** for replacements.

## tools required

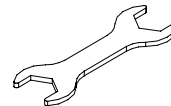

hex wrench (included)

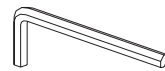

allen wrench (included)

## components

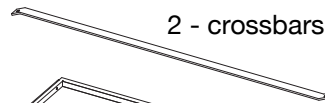

2 - crossbars

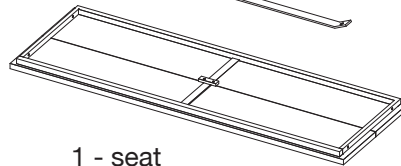

1 - seat

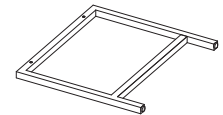

2 - leg assemblies

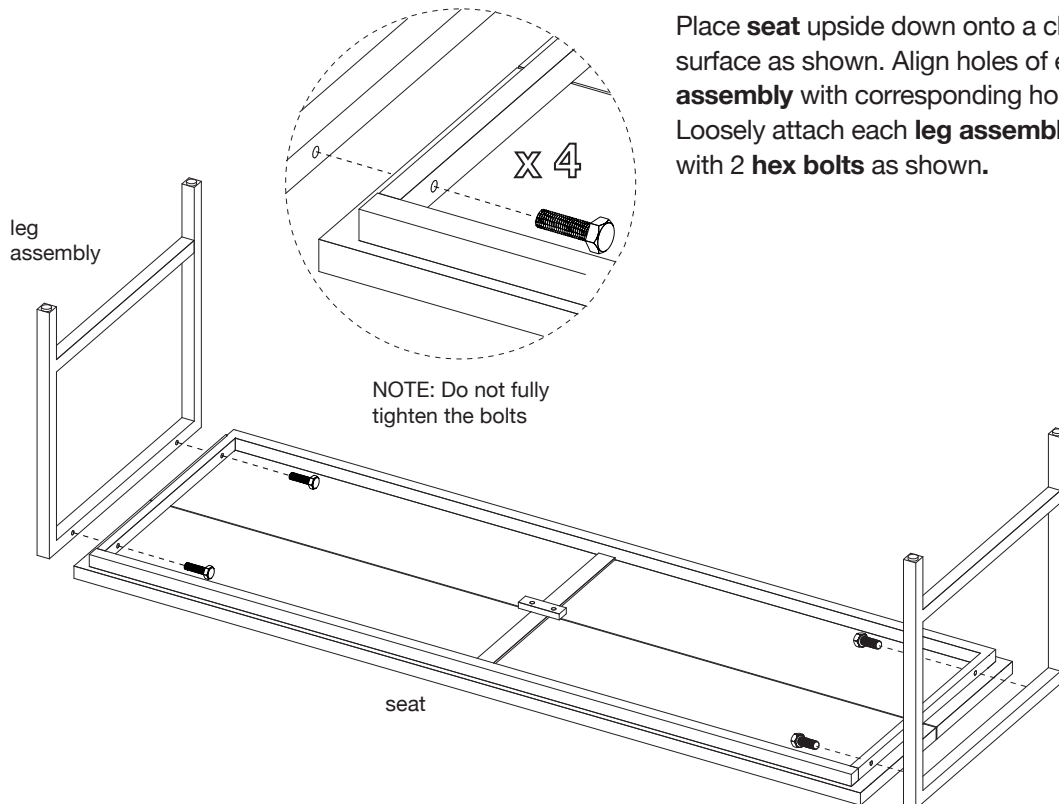

Place **seat** upside down onto a clean, padded surface as shown. Align holes of each **leg assembly** with corresponding holes of **seat**. Loosely attach each **leg assembly** to **tabletop** with 2 **hex bolts** as shown.

1

**2**

NOTE: Make sure ends of each crossbar are flush with the leg frame and seat

crossbar

crossbar

seat

leg frame

**A X 4**

**B X 4**

NOTE: Do no over tighten the bolts

NOTE: Make sure ends of each crossbar are flush with the leg frame and seat

A. Loosely attach 2 **crossbars** to **seat** and **leg frames** with 2 **allen bolts** per crossbar as shown. Make sure the ends of each crossbar are flush with the assembly. At this point, fully tighten all **allen bolts** with an **allen wrench**. Do not over tighten the bolts.

B. Fully tighten all **hex bolts** with a **hex wrench** as shown. With the assistance of another adult, place assembled unit upright.

Assembly is now complete.

## method to adjust levelers on table

leg

leveler

**NOTE: This table comes with pre-attached levelers. Please do the following if your table is not level.**

With the assistance of another adult, adjust levelers of each leg as necessary.

## cleaning & care

Clean surfaces with a dry soft cloth. Do not use abrasive cleaners. Furniture wax can be used, as this item has already been finished with a natural wax over a protective clear lacquer. It is recommended to use coasters to protect surface from heat and water.