

This page lists the contents included in the box. Please take time to identify the hardware as well as the individual components of the product. As you unpack and prepare for assembly, place the contents on a carpeted or padded area to protect them from damage. Please follow the assembly instructions closely. Improper assembly can result in personal or property damage.

IMPORTANT SAFETY INSTRUCTIONS:
If you are unsure about your ceiling type or what mounting method you should use, consult a qualified professional or your local hardware store.

We recommend installation of this lamp be performed by a licensed electrician.

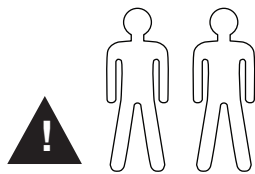
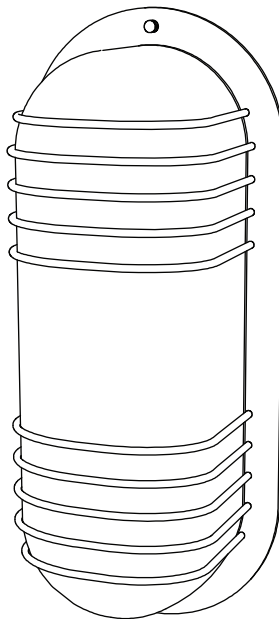

hardware & components

800.606.6387



1 - mounting plate



2 - cap screws

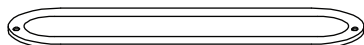

1 - rubber gasket



2 - mounting bolts

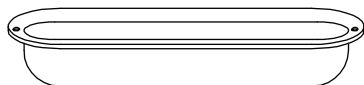

1 - shade

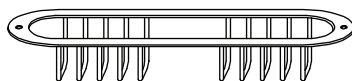

1 - cage frame



3 - wire nuts

tools required



electrical tape

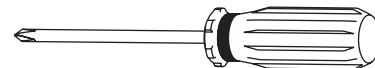

phillips head screwdriver

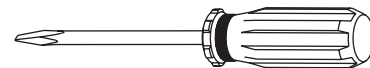

flat head screwdriver

cleaning & care

Dust surfaces with a dry soft cloth. Do not use cleaners or polishes on the lamp.

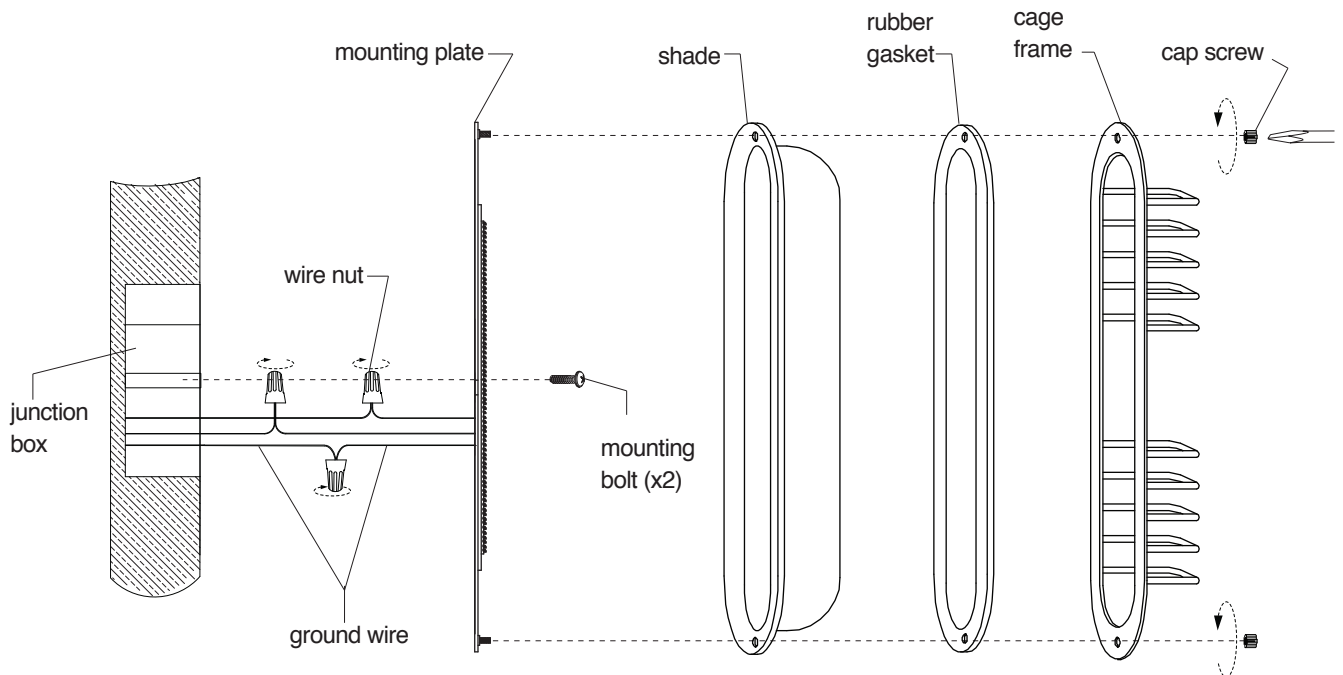

- 1) Shut off the main electrical supply from the main fuse box/circuit breaker.
 - 2) Carefully unpack all fixture parts and hardware. Lay items out on a clear workspace.
 - 3) Gently pull wiring from junction box and allow it to hang.
 - 4) Carefully inspect the lamp fixture's wires:
 - *Neutral fixture wire* = white
 - *Hot fixture wire* = black
 - *Ground wire* = green
 - 5) Attach the *ground wire* of the lamp assembly to the *ground wire* from the junction box and fasten each together with a **wire nut**. Wrap the connection with **electrical tape**.
 - 6) Attach the *neutral fixture wire* from the lamp to the *neutral junction box wire* (usually white). Fasten each together with a **wire nut** and wrap the connection with **electrical tape**.
 - 7) Attach the *hot fixture wire* from the lamp to the *hot junction box wire* (usually black). Fasten each together with a **wire nut** and wrap the connection with **electrical tape**.
- DO NOT REVERSE THE HOT AND NEUTRAL CONNECTIONS OR SAFETY WILL BE COMPROMISED.
- 8) Gently tuck wire connections neatly into the junction box.
 - 9) Place the **mounting plate** over the center of the junction box. Align holes in **mounting plate** with holes in junction box and attach with 2 **mounting bolts**, using a **phillips head screwdriver**.
 - 10) Fit **shade**, **rubber gasket** and **cage frame** over bolts of **mounting plate** as shown. Secure with 2 **cap screws** using a **flat head screwdriver**.
 - 11) Restore power to junction box and test fixture.
- Installation is now complete.