

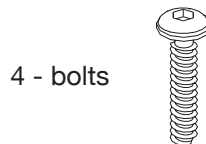

## hardware



Missing hardware?  
Please call 800.606.6387 for replacements.

## components

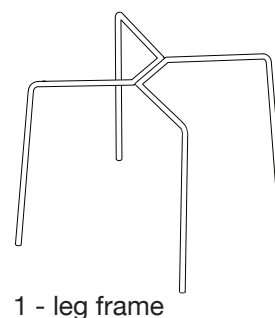
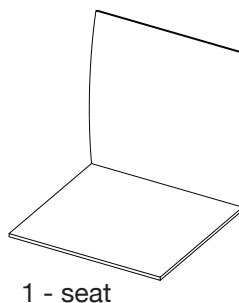

## tools required

Allen Wrench (included) 

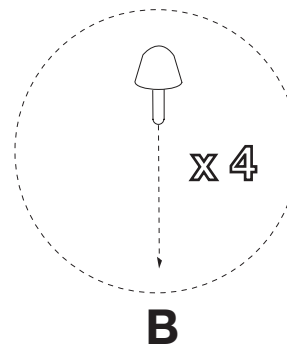
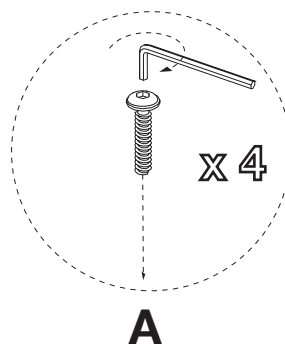
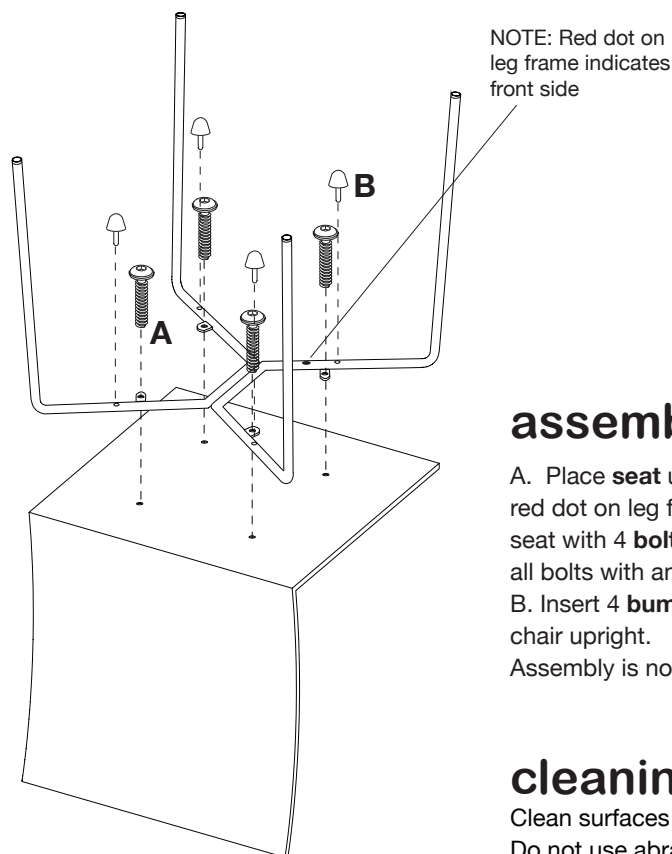

## assembly

A. Place **seat** upside down onto a clean, padded surface as shown. Locate the red dot on leg frame to determine the front side. Loosely attach **leg frame** onto seat with 4 **bolts** as shown. Adjust leg frame as needed. At this point, fully tighten all bolts with an **allen wrench**.

B. Insert 4 **bumpers** into **leg frame** as shown. Press firmly to secure. Position chair upright.

Assembly is now complete.

## cleaning and care

Clean surfaces with a dry or damp soft cloth.  
Do not use abrasive cleaners.