

Thank you for purchasing the **Peg Leg Queen or King Bed**. This page lists all the contents included in the box. Please take the time to identify the hardware as well as the individual components to this product. As you unpack and prepare for assembly, place the contents on a carpeted or padded area to protect them from damage.
 Note: 2 people are recommended to safely assemble this product.

hardware

Missing hardware?
 Please call **800.606.6387**
 for replacements.

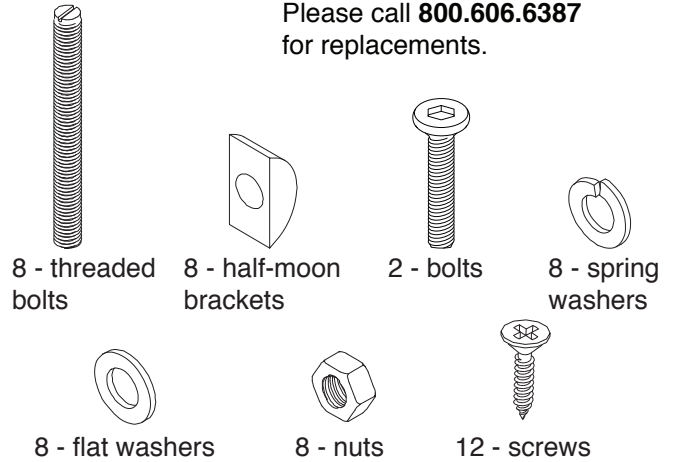

tools required

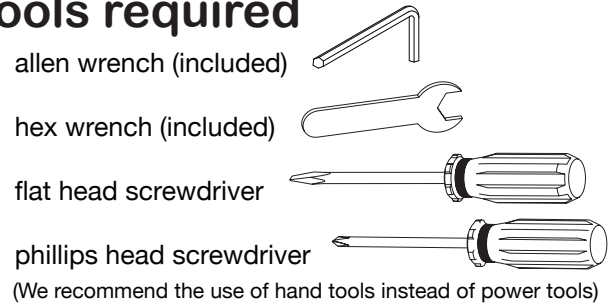

components

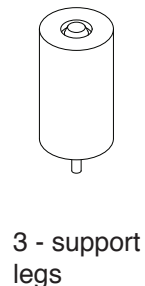
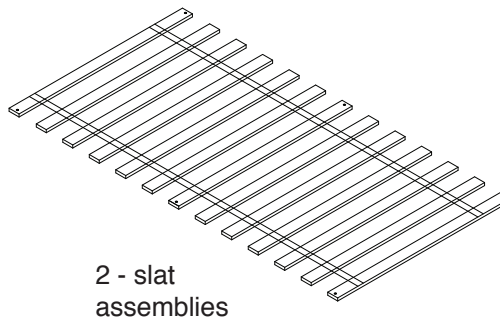
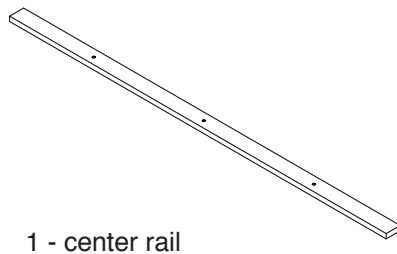
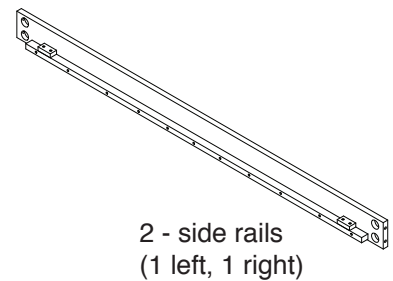
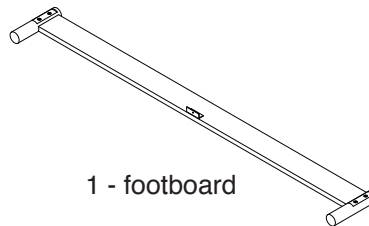
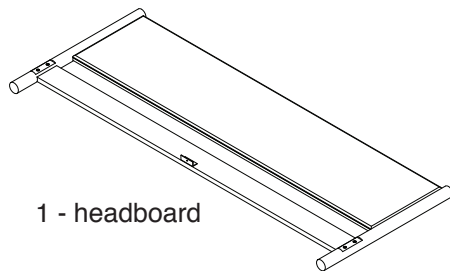

NOTE: Do not over tighten the bolts

A
headboard

B
footboard

1

A. Attach 4 **threaded bolts** to **headboard** as shown. Secure, but do not over tighten, bolts with a **flat head screwdriver**.

B. Attach 4 **threaded bolts** to **footboard** as shown.

NOTE: Do not over tighten the hex nuts

A

B

headboard

left side rail

right side rail

footboard

2

A. With the assistance of another adult, fit **left and right side rails** into threaded bolts of **headboard and footboard** as shown.

B. Loosely insert 2 **half-moon brackets**, 2 **spring washers**, 2 **flat washers** and 2 **hex nuts**. Loosely attach nuts with a **hex wrench** as shown. *Repeat steps 2A-B for each corner.*

leg support

center rail

3

Attach 3 **leg supports** to bottom of **center rail** as shown. Turn each leg support clockwise to secure.

4

A. Fit **center rail** to corresponding support bracket on **headboard** and **footboard**, and loosely attach with **2 bolts**, using an **allen wrench**. Do not over tighten the bolts.

B. At this point, go back and tighten all **hex nuts** and **screws** with the **hex wrench** as shown.

center rail assembly

5

With assistance of another adult, place **slat assembly** onto side and center rails. Attach each slat assembly with **6 screws** as shown secure with a **phillips head screwdriver**. Assembly is now complete.

NOTE: Make sure straps of slat assembly are facing down during assembly

cleaning & care | Clean surfaces with a dry or damp soft cloth. Do not use abrasive cleaners. Do not use furniture wax or polish as the unit is finished with a protective clear lacquer.