

Thank you for purchasing the **Mojito Rocker**. This page lists all the contents included in the box. Please take the time to identify the hardware as well as the individual components to this product. As you unpack and prepare for assembly, place the contents on a carpeted or padded area to protect them from damage.
 Note: 2 people are required to safely assemble this product.

hardware

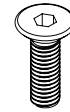

8 - small bolts

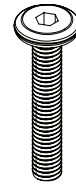

4 - large bolts

Missing hardware? Please call **800.606.6387** for replacements.

tools required

allen wrench (included)

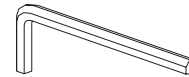

components

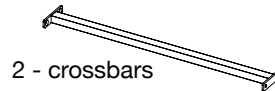

2 - crossbars

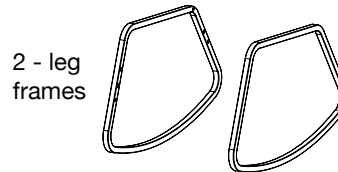

2 - leg frames

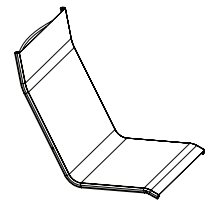

1 - seat assembly

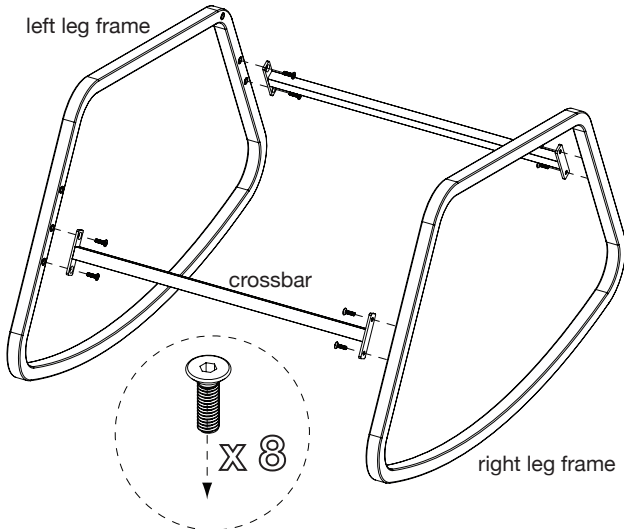

NOTE: Do not over tighten the bolts

Attach 2 **crossbars** to **left and right leg frames** with 4 **small bolts** per crossbar as shown. Secure, but do not over tighten, with an **allen wrench**.

1

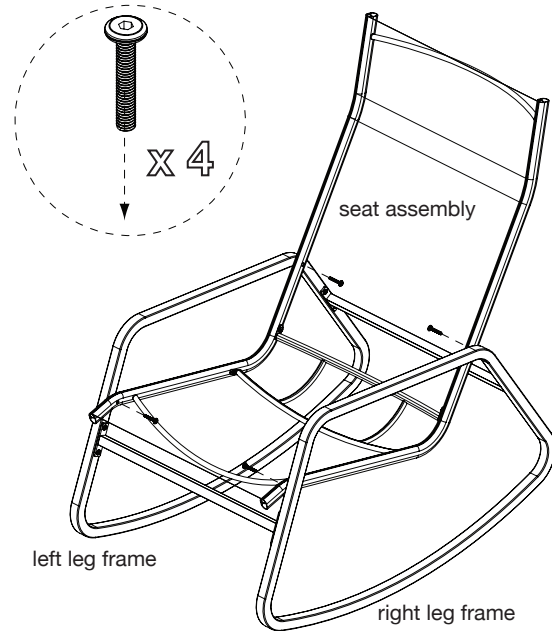

Attach **seat assembly** to **leg frame assembly** with 4 **large bolts** as shown. Assembly is now complete.

2

cleaning and care

Clean surfaces with a dry or damp soft cloth. Do not use abrasive cleaners. It is recommended to cover the table in inclement weather. Periodically check bolts and tighten as necessary.