

Thank you for purchasing the **Matchbox Low Dresser**. This page lists all the contents included in the box. Please take time to identify the hardware as well as the individual components of this product. As you unpack and prepare for assembly, place the contents on a carpeted or padded area to protect them from damage.
NOTE: 2 people are required to safely assemble this product.

hardware

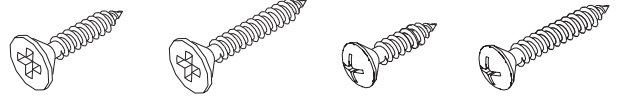

8 - small screws

42 - large screws

4 - support leg screws

6 - leg screws

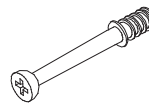

22 - cam screws



32 - small wood dowels

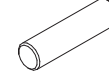

32 - large wood dowels



16 - small cams



6 - large cams

Missing hardware?
Please call **800.606.6387** for replacements

tools required

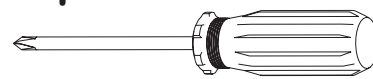

phillips head screwdriver

(We recommend the use of hand tools instead of power tools)

components

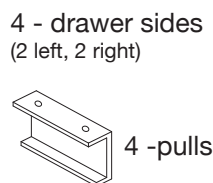
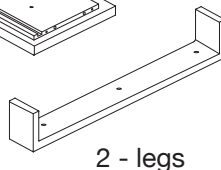
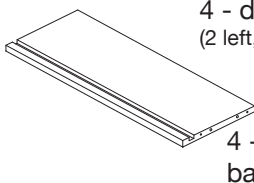
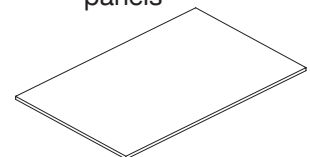
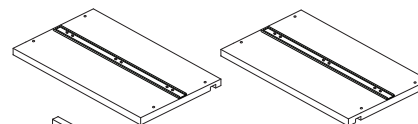
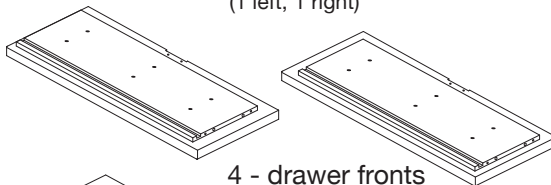
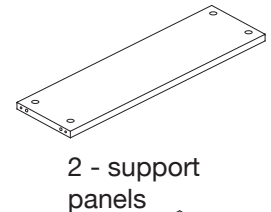
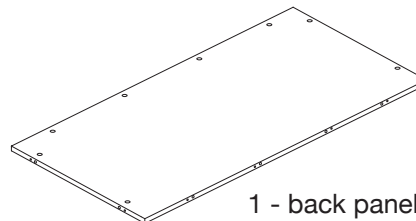
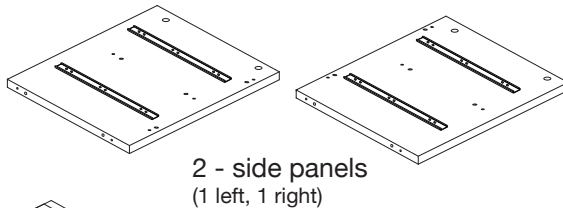
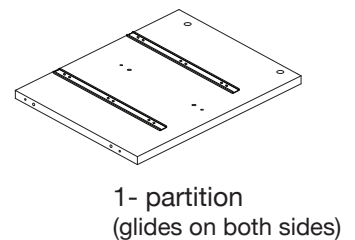
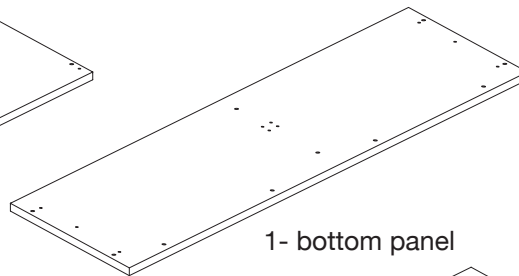
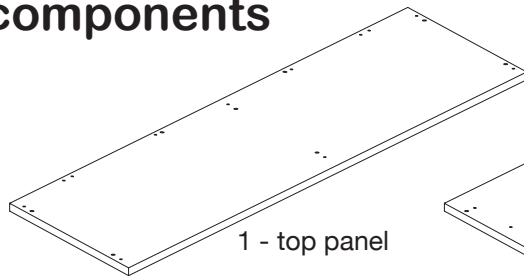

NOTE: Make sure arrows on each cam points toward the nearest edge with holes

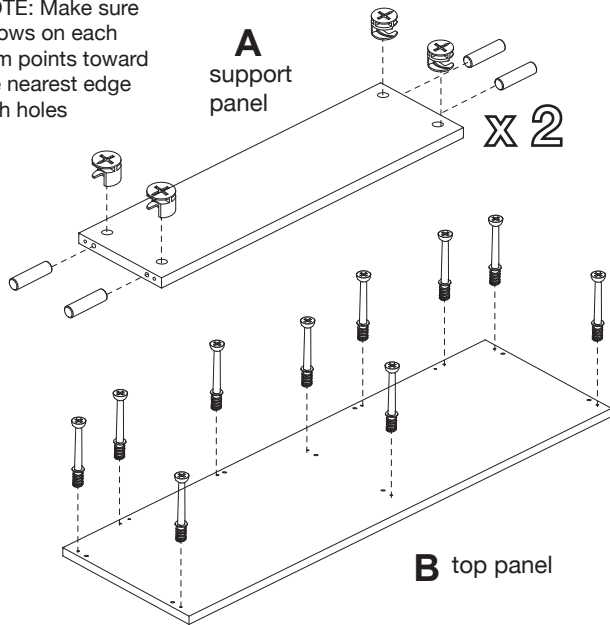

A) Insert 4 **small cams** and 4 **large wood dowels** into each **support panel** as shown. Make sure arrows on each cam points toward the nearest edge with holes.

B) Insert 10 **cam screws** in **top panel** and secure with a **Phillips head screwdriver**.

1

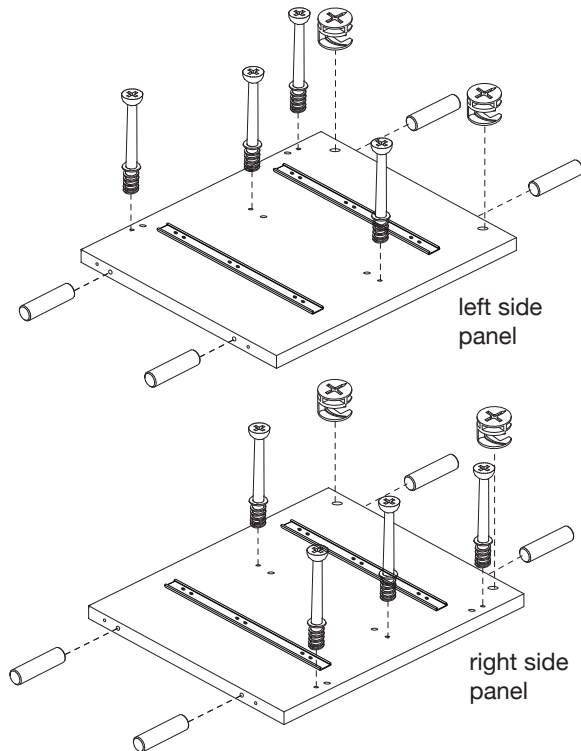

Insert 2 **large cams**, 4 **cam screws** and 4 **large wood dowels** into **left/right side panels**.

2

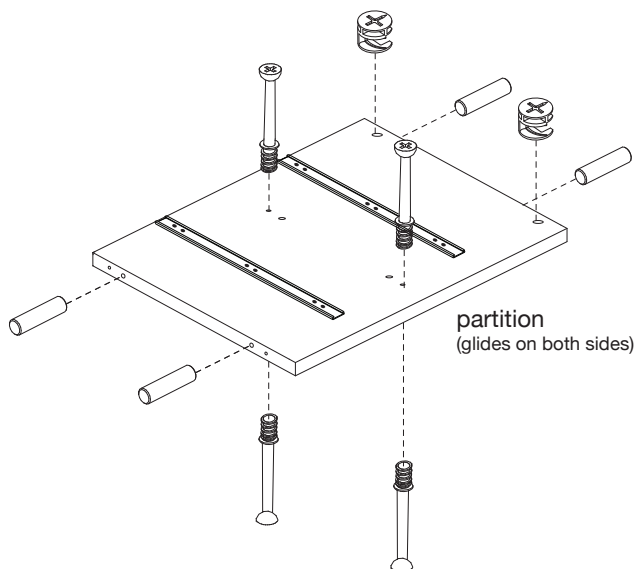

Insert 2 **large cams**, 4 **cam screws** and 4 **large wood dowels** into **partition**.

3

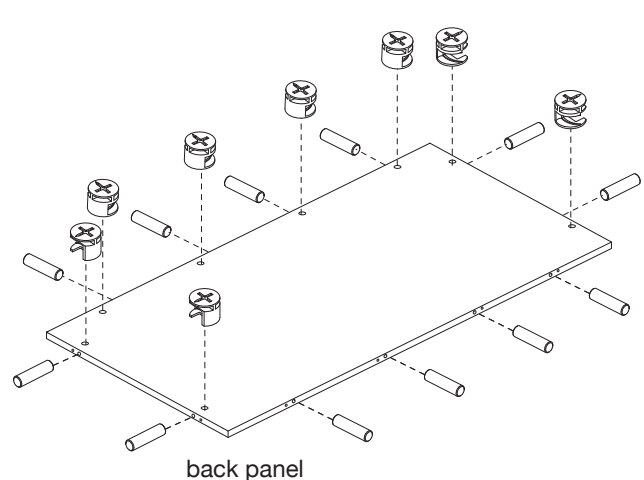

Insert 8 **small cams** and 12 **large wood dowels** into **back panel** as shown.

4

5

Fit dowels of **support panels** into corresponding holes of **left and right side panels** as shown. Using a screwdriver, turn each **cam** clockwise until it securely engages each cam screw.

NOTE: Make sure all cams in the panels are oriented as shown towards the top

6

A) Place **back panel** onto clean, padded surface. Fit dowels of **back panel** into corresponding holes of **left side panel**. Secure **cams** on back panel.

B) Fit dowels of **support panel** into corresponding holes of **partition** as shown. Secure **cams** on **support panel**. Repeat steps 6A-B for **right side panel**.

7

Fit dowels of assembled unit into corresponding holes of **bottom panel**. Secure with 10 **large screws** using a screwdriver. Do not over tighten the screws.

NOTE: Do not over tighten the screws

8

A) Attach 2 **legs** with 3 **leg screws** per leg using a screwdriver.

B) Attach **support leg** with 4 **support leg screws** and secure using a screwdriver.

top panel

9 With the assistance of another adult, position unit upright. Fit dowels of assembled unit into corresponding holes of **top panel**. Secure all **cams**.

drawer front

B pull

A

drawer back

10 A) Insert 4 **small wood dowels** into **drawer front and drawer back**.
B) Attach 1 **pull** to **drawer front panel** as shown with 2 **small screws** using a screwdriver.

NOTE: Make sure the open end of the glide is oriented towards the back panel, and all grooves line-up

drawer right side

drawer back

11 Fit dowels of **drawer front and back** into corresponding holes of **drawer right side**. Secure with 4 **large screws** using a screwdriver.

A

B

drawer bottom

drawer left

12 A) Slide **drawer bottom** into corresponding grooves of drawer assembly as shown.
B) Fit dowels of **drawer front and back** into corresponding holes of **drawer left side**. Secure with 4 **large screws** using a screwdriver. *Repeat steps 10-12 for remaining drawers.*

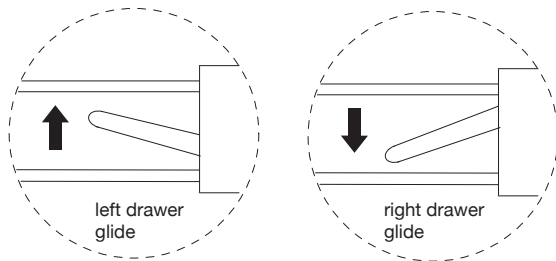

left drawer glide

right drawer glide

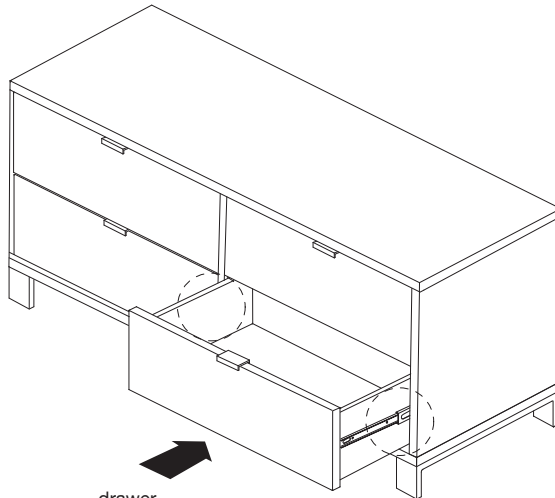

drawer assembly

13

A) Attach drawer assembly to assembled unit:

Fit drawer glides of drawer assembly into corresponding drawer glides of unit. Push drawer all the way into the assembled unit. Test the drawer by opening and closing a couple of times to ensure it is attached.

Assembly is now complete.

B) To remove drawer assembly from assembled unit:

Fully extend drawer assembly from unit. Locate plastic tabs on left and right drawer glides. With even pressure, simultaneously lift the left tab and push down the right tab and pull the drawer from the assembled unit.

cleaning and care

Clean surfaces with a dry or damp soft cloth. Do not use abrasive cleaners. Do not use furniture wax or polish as the wood is finished with a protective clear lacquer.