

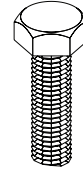

Thank you for purchasing the **Lineage dining table**. This page lists all the contents included in the box. Please take the time to identify the hardware as well as the individual components to this product. As you unpack and prepare for assembly, place the contents on a carpeted or padded area to protect them from damage.  
Note: 2 people are recommended to safely assemble this product.

## hardware



16 - hex bolts

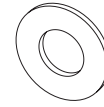

16 - flat washers

Missing hardware?  
Please call **800.606.6387** for replacements.

## tools required

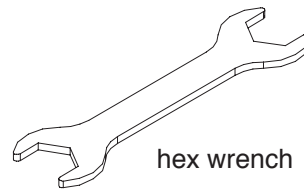

hex wrench (included)

## components

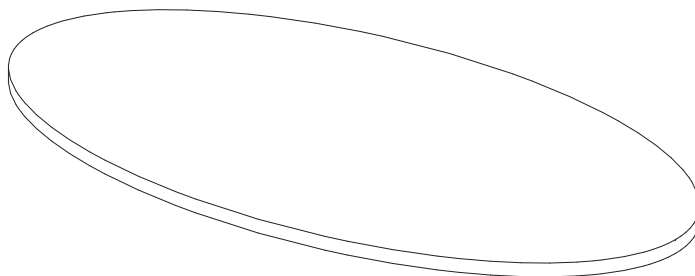

1 - top panel

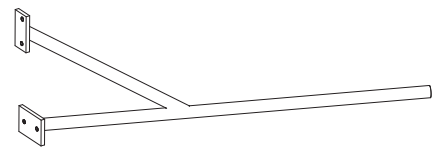

4 - legs  
(2 labelled A, 2 labelled B)

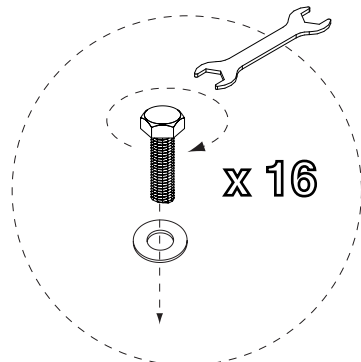

With assistance of another adult, place **top panel** upside down onto a clean, padded surface as shown. Position **leg A** over mounting block on top panel marked A. Attach **leg A** to **top panel** with 4 **hex bolts** and 4 **flat washers** as shown. Turn each bolt clockwise with a **hex wrench** to secure.

Repeat for remaining legs.

Position unit upright.

Assembly is now complete.

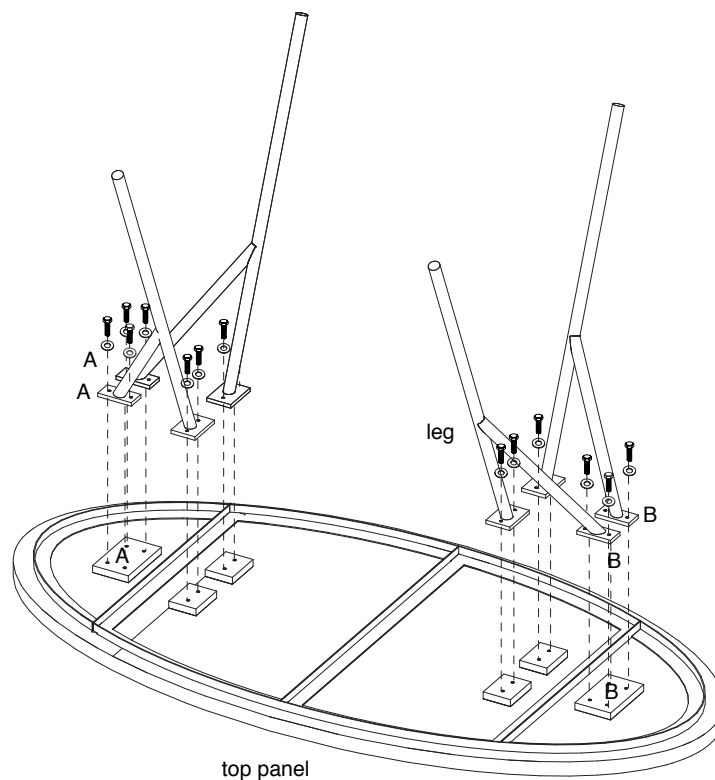

**1**

## cleaning and care

Clean surfaces with a dry or damp soft cloth. Do not use abrasive cleaners. It is recommended to use coasters to protect surface from heat and water.