

Thank you for purchasing the **Hyde Open Wall Cabinet**. This page lists all the contents included in the box. Please take the time to identify the hardware as well as the individual components to this product. As you unpack and prepare for assembly, place the contents on a carpeted or padded area to protect them from damage.

Note: 2 people are recommended to safely assemble this product.

assembly hardware



20 - wood dowels



8 - cam screws



8 - cams



8 - cam covers

wall mounting hardware



6 - large screws

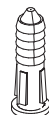

6 - plastic anchors

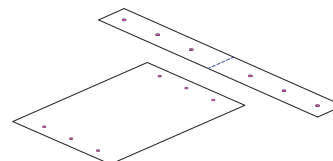

2 - wall templates
(1 horizontal, 1 vertical)

Missing hardware?
Please call **800.606.6387** for replacements.

tools required

Phillips head screwdriver 

hammer 

level 

(We recommend the use of hand tools instead of power tools)

components

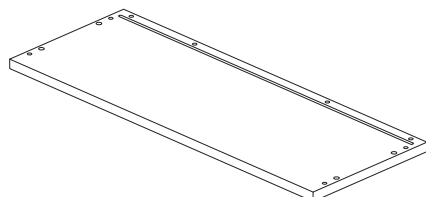

1 - top panel

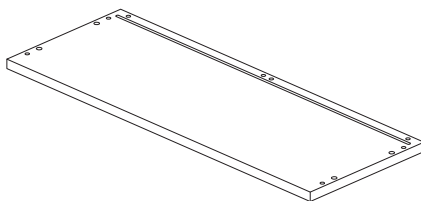

1 - bottom panel

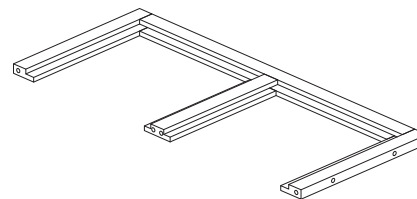

1 - back frame

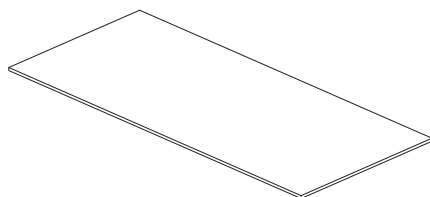

1 - back panel

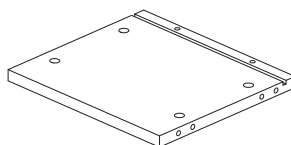

2 - side panels
(1 left, 1 right)

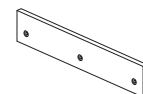

2 - wall brackets

NOTE: Do not over tighten cam screws

A
top panel

B
bottom panel

1 A. Insert 4 **cam screws** and 8 **wood dowels** into **top panel** as shown. Secure, but do not over tighten, cam screws with a **phillips head screwdriver**.
B. Insert 4 **cam screws** and 8 **wood dowels** into **bottom panel** as shown.

NOTE: Make sure arrows on each cam points toward nearest edge with holes

A
left and right side panels

B
right side panel

x 2

back frame

left side panel

2 A. Insert 2 **wood dowels** and 4 **cams** into **left and right side panels**. Make sure arrows on each cam points towards nearest edge with holes.
B. Fit dowels of **left and right side panels** into corresponding holes of **back frame** as shown.

B

A

top panel

3 A. Fit dowels and cam screws of **top panel** into assembly as shown.
B. Using a screwdriver, turn **cams** clockwise to secure. Make sure cam securely engages each cam screw.

back panel

4 Fit **back panel** into corresponding grooves of assembly as shown.

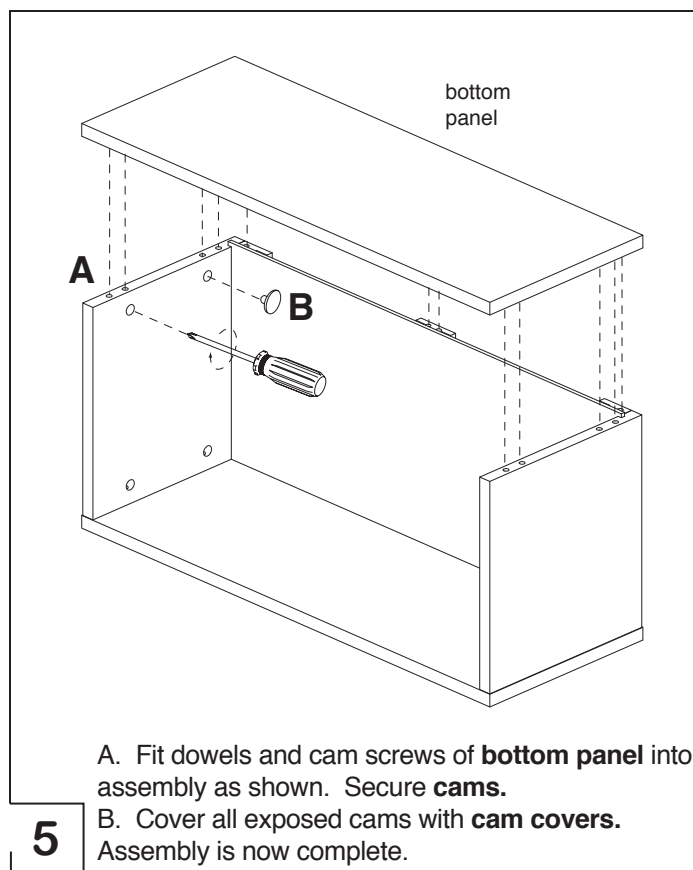

CLEANING AND CARE

Clean surfaces with a dry or damp soft cloth. Do not use abrasive cleaners. Do not use furniture wax or polish as the unit is finished with a protective clear lacquer.

wall mounting assembly

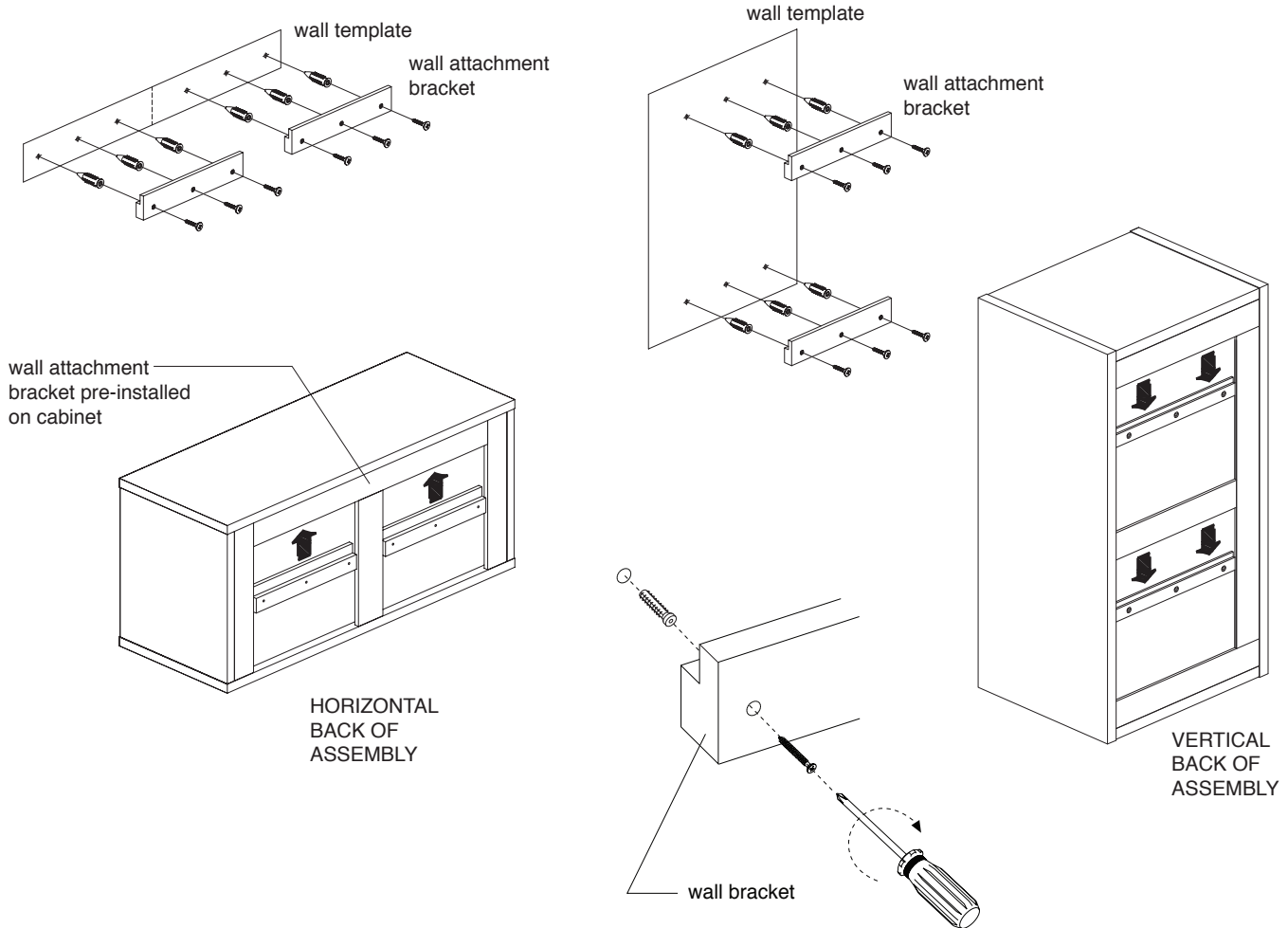

The wall mounting hardware included with this wall cabinet is intended for **drywall installation only**. Be sure to use hardware appropriate for your wall type. Whenever possible, fasten screws directly into a wall stud. If you are unsure about your wall type or what mounting method you should use, consult a qualified professional or your local hardware store.

1. **Determine the wall cabinet orientation** (vertical or horizontal) **and wall location**. Using a level for the provided **wall template**, level and mark hole positions for wall bracket as shown. Discard wall template.
2. If attaching directly into wall studs, skip to Step 4.
3. For drywall installation, drill a hole slightly smaller in diameter than the anchor. Insert 1 **plastic anchor** at each marked hole location and gently tap with a **hammer** until the head of each anchor is flush to the wall surface.
4. Insert 1 **large screw** through each hole in the **wall bracket** and into the corresponding anchors or studs in the wall. Fully tighten each screw with a **Phillips head screwdriver** but do not over tighten.
5. With the assistance of another adult, fit the bracket on the back of the unit onto the wall bracket. Make sure the unit is firmly seated in the wall bracket.

Wall attachment is now complete.