

Thank you for purchasing the **Grid Media Console**. This page lists all the contents included in the box. Please take the time to identify the hardware as well as the individual components to this product. As you unpack and prepare for assembly, place the contents on a carpeted or padded area to protect them from damage.
NOTE: Due to size, 2 people are required to safely assemble this product.

hardware

Missing hardware?
Please call **800.606.6387** for replacements.

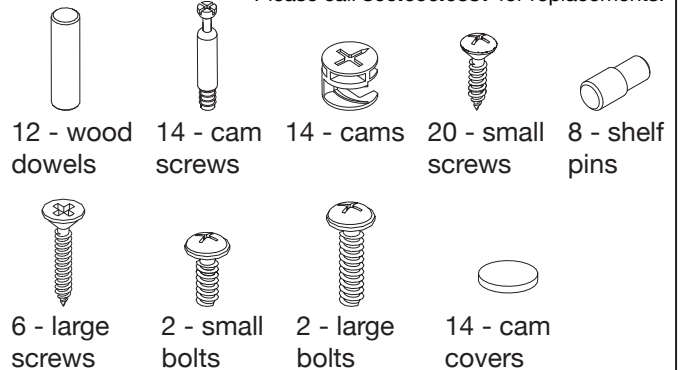

mounting hardware

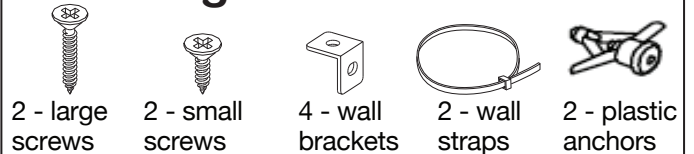

tools required

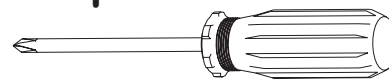

Phillips head screwdriver

(We recommend the use of hand tools instead of power tools)

components

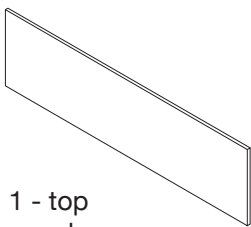

1 - top panel

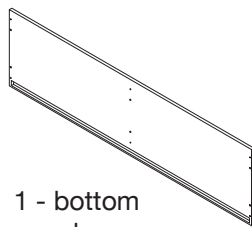

1 - bottom panel

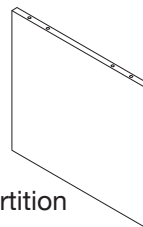

1 - partition

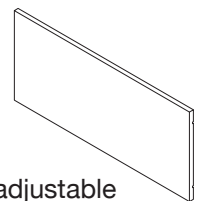

2 - adjustable shelves

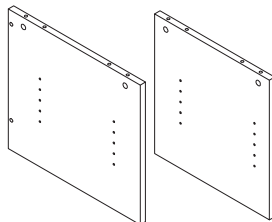

2 - side panels
(1 left, 1 right)

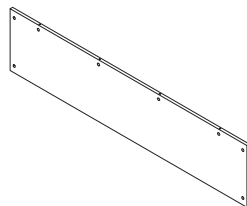

1 - back panel

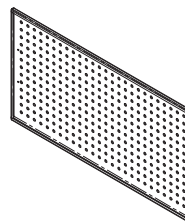

1 - right door

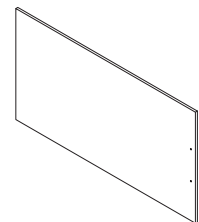

1 - left door

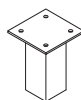

5 - legs

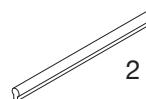

2 - pulls

NOTE: Do not over tighten the cam screws

A left and right side panels

NOTE: Make sure arrows on each cam point toward nearest edge with holes

1

A. Insert 2 **cam screws**, 4 **wood dowels** and 2 **cams** into **left and right side panels** as shown. Secure, but do not over tighten, cam screws with a **phillips head screwdriver**. Make sure arrows on each cam point toward nearest edge with holes.

B. Insert 2 **cams** and 4 **wood dowels** into **partition**.

2 Insert 8 **cams** into **back panel** as shown.

3 Insert 10 **cam screws** into **top panel** as shown.

4 Fit cam screws of **left and right side panels** into corresponding holes of **back panel** as shown. Turn each cam clockwise with a screwdriver until it securely engages each cam screw.

partition

bottom panel

leg

A X 20

B X 2

NOTE: Do not over tighten the screws

5

A. Attach 5 legs to bottom panel as shown with 4 small screws per leg, using a screwdriver.
 B. Fit dowels of partition into corresponding holes of bottom panel and secure with 2 large screws as shown, using a screwdriver.

left side panel

right side panel

X 4

With assistance of another adult, fit dowels of left and right side panels into corresponding holes of bottom panel, and secure with 4 large screws as shown.

6

pull

left door

right door

A X 2

B X 2

NOTE: Do not over tighten the bolts

A. Attach 1 pull to left door with 2 large bolts, using a screwdriver.
 B. Attach 1 pull to right door with 2 small bolts.

7

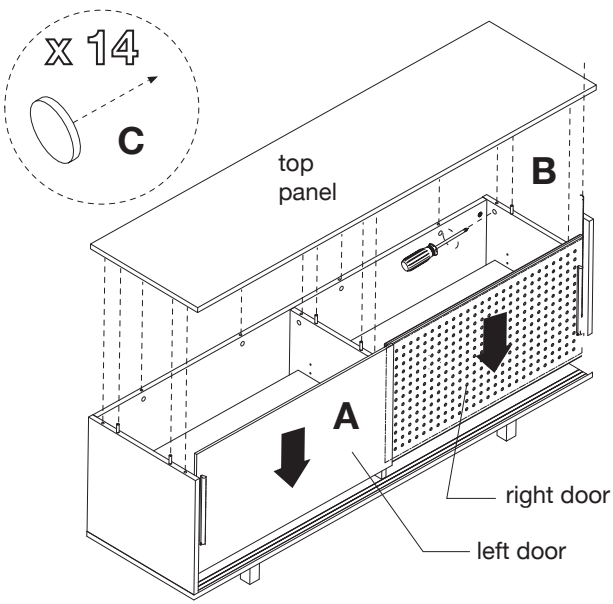

8

A. Fit **left door** into front groove and **right door** into back groove of **bottom panel** as shown.

B. Align grooves and holes in **top panel** with corresponding doors and dowels of assembly. Place into position as shown. Slide open doors and secure all **cams**.

C. Cover all exposed cams with **cam covers**.

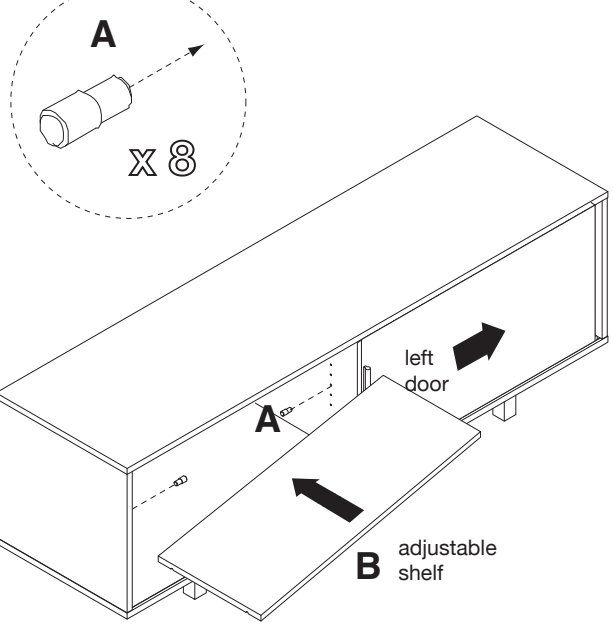

9

A. Slide open **left door** and insert 4 **shelf pins** at desired shelf heights.

B. Place 1 **adjustable shelf** into assembly. Make sure each shelf is securely supported by shelf pins. Close **left door**.

Repeat steps 9A-B for **right door**.
Assembly is now complete.

cleaning and care

Clean surfaces with a dry or damp soft cloth. Do not use abrasive cleaners. Do not use furniture wax or polish as the unit is finished with a protective clear lacquer.

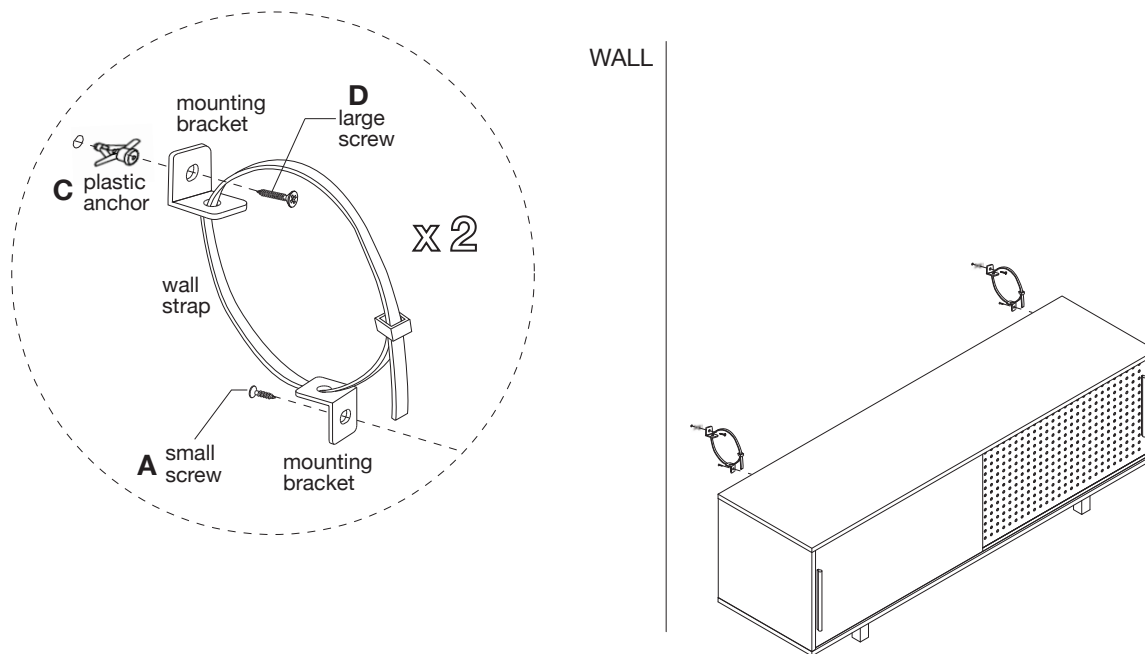

wall mounting assembly

NOTE:

If you are unsure about your wall type or what mounting method you should use, consult a qualified professional or your local hardware store.

For added safety and stability, it is recommended that the wall mounting hardware be installed. For safe mounting, it is essential to use wall anchors appropriate to your wall type (i.e. plaster, drywall, concrete, etc.). Mount to wood studs whenever possible.

- A) Attach 2 **mounting brackets** to top of unit using 1 **small screw** per bracket.
- B) Determine the final location of unit. Mark position on the wall, approximately 2" below each mounting brackets mounted to the back of the unit.
- C) Drill a hole in the wall stud. If the wall stud is not available, drill a hole in the wall that is slightly smaller in diameter than the anchor. Gently tap the **plastic anchor** until the flange of the anchor is flush with the wall.
- D) Attach the **mounting brackets** to the wall by inserting 1 **large screw** through each mounting bracket and into the wall anchor in the wall.
- E) Position the unit so the mounting bracket on the back edge is allowed with the wall bracket.
- F) Lace one end of each **wall strap** through corresponding brackets, and into the other end of the strap.
- G) Pull the straps tightly until secure.

Wall mounting assembly is now complete.