

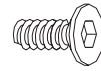

Thank you for purchasing the **Grain Chair**. This page lists all the contents included in the box. Please take time to identify the hardware as well as the individual components of this product. As you unpack and prepare for assembly, place the contents on a carpeted or padded area to protect them from damage.

hardware



5 - small bolts

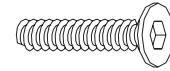

4 - large bolts



9 - spring washers



4 - plastic brackets

Missing hardware? Please call **800.606.6387** for replacements.

components

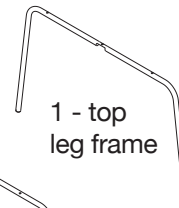

1 - top leg frame

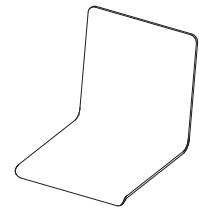

1 - seat

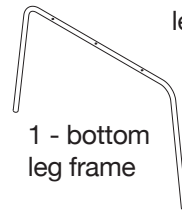

1 - bottom leg frame



1 - connecting plate

tools required

allen wrench (included)

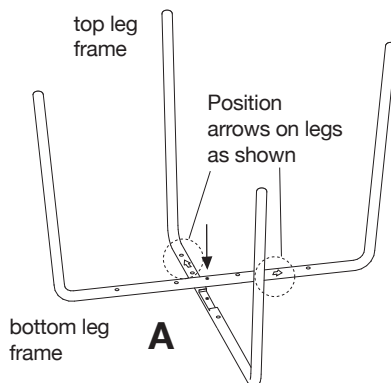

A) Fit **bottom leg frame** into corresponding notch of **top leg frame** as shown. Make sure arrows on legs are positioned as shown.

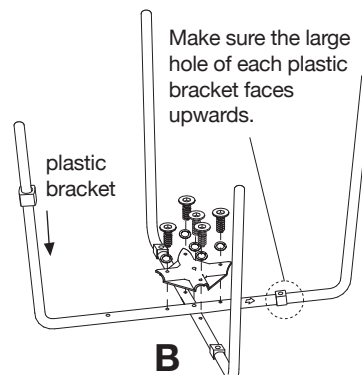

B) Attach **connecting plate** to leg assembly with 5 **small bolts** and 5 **spring washers**, using an **allen wrench**. Slide 2 **plastic brackets** over corresponding holes in each **leg frame** as shown.

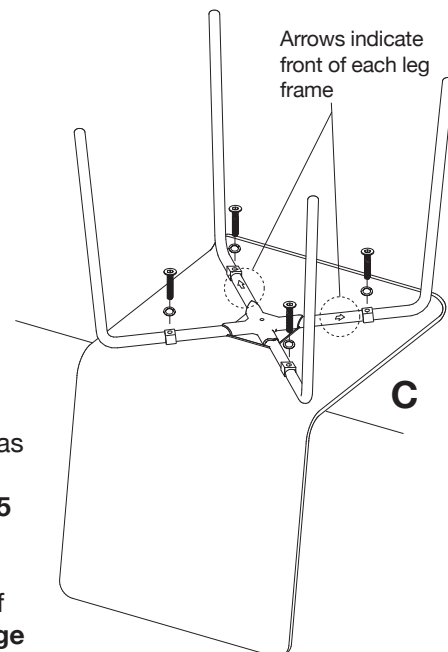

C) Place **seat** onto a clean, padded surface as shown. Align pads of leg assembly with corresponding holes of **seat** and secure with 4 **large bolts** and 4 **spring washers**, using an **allen wrench**. Position chair upright.

Assembly is now complete.

cleaning & care

Clean surfaces with a dry or damp soft cloth. Do not use abrasive cleaners. Periodically re-tighten bolts.