

Thank you for purchasing the **Go Cart Bookcase**. This page lists all the contents included in the box. Please take the time to identify the hardware as well as the individual components to this product. As you unpack and prepare for assembly, place the contents on a carpeted or padded area to protect them from damage. Note: 2 people are required to safely assemble this product.

## hardware



40 - bolts



40 - nuts

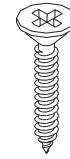

2 - screws



4 - spring washers



2 - plastic anchors



2 - brackets

Missing hardware? Please call **800.606.6387** for replacements.

## tools required

hex wrench (included)

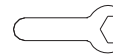

hex wrench (included)

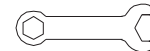

allen wrench (included)



phillips head screwdriver

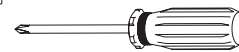

## components

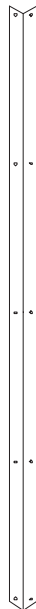

4 - supports

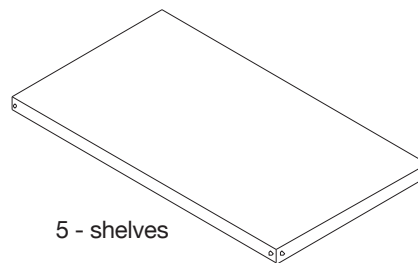

5 - shelves



2 - wheels



2 - locking wheels

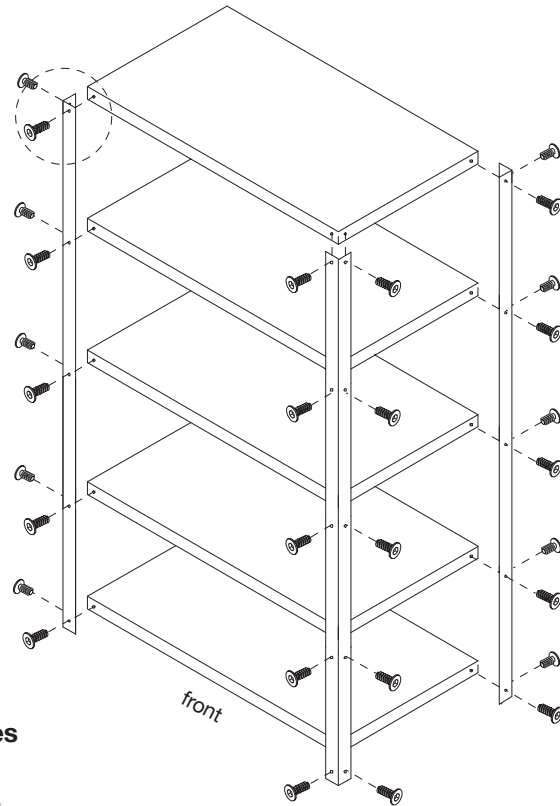
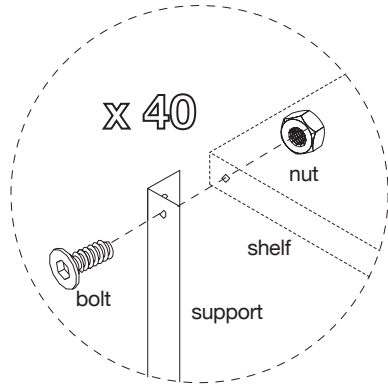

1

With the assistance of another adult, attach 5 **shelves** to 4 **supports** as shown with 40 **bolts** and 40 **nuts**. Secure bolts with an **allen wrench** and **hex wrench**.

A. Attach 2 **spring washers** and 2 **locking wheels** to front of assembly as shown. Fasten wheels with a **hex wrench**.  
B. Attach 2 **spring washers** and 2 **wheels** to back of assembly as shown. Assembly is now complete.

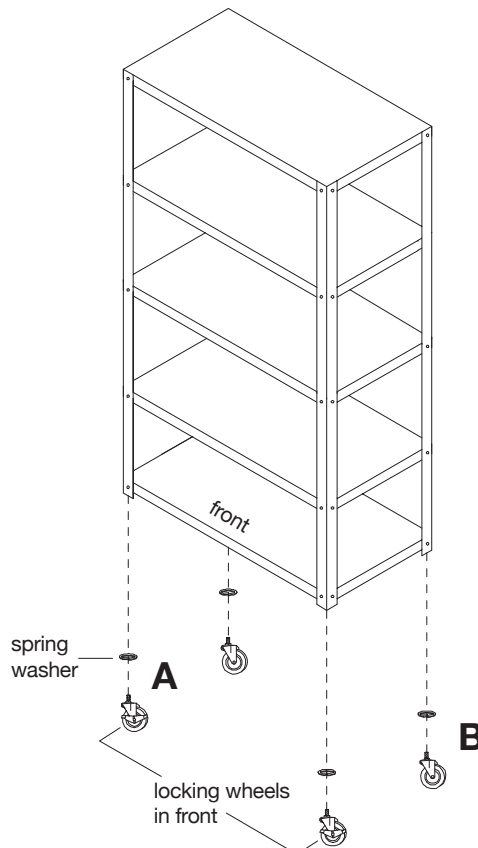

2

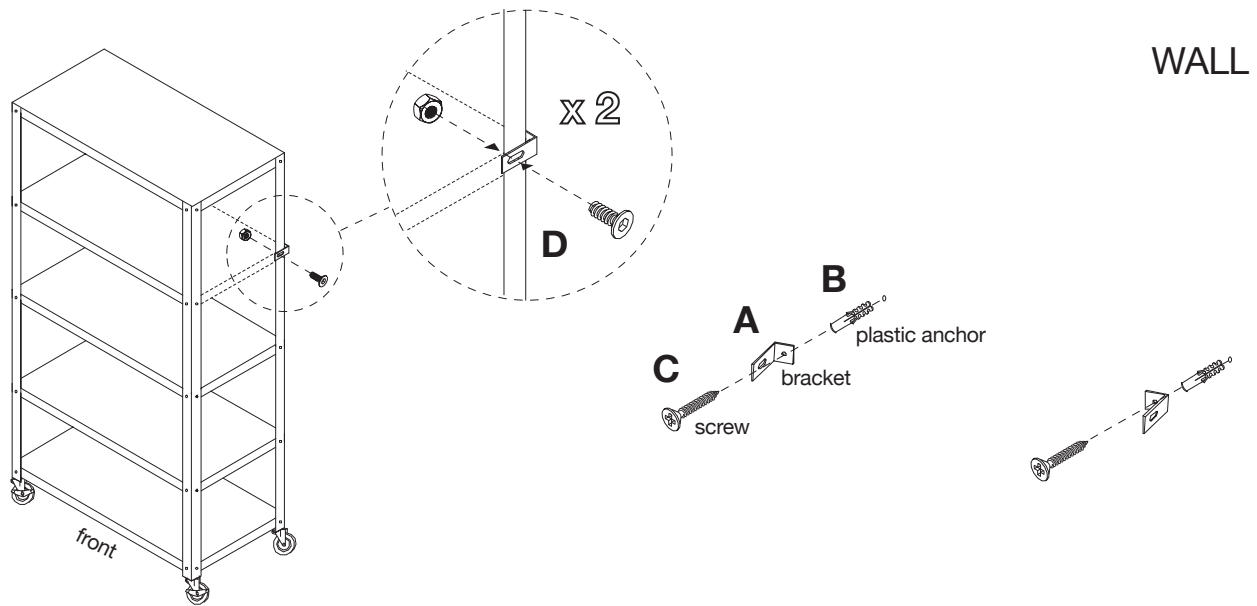

### WALL ATTACHMENT INSTRUCTIONS

NOTE: When properly installed, this wall bracket may provide protection from unexpected tipping of shelf due to bumping or shaking. To avoid injury due to these instances, use of wall brackets are recommended.

Although basic wall mounting hardware is included, be sure the use the proper hardware for your wall type. When in doubt, please consult your local hardware store.

- A. With the assistance of another adult, place the unit in desired location against the wall. Mark the location of the hole in the **bracket** of the wall. Move the bookcase out of the workspace.
- B. Drill holes slightly smaller in diameter than the **plastic anchors**. Insert the **plastic anchor** into the holes until they are flush to the wall.
- C. Attach 1 **bracket** to each **plastic anchor** with 1 **screw**. Secure, but do not over tighten, screw with a **phillips head screwdriver**.
- D. Remove 2 **bolts** and 2 **nuts** from bookcase. Position bookcase in between 2 **brackets** on the wall. Secure 2 **brackets** to bookcase with 2 **bolts** and 2 **nuts** as shown.

Wall mounting installation is now complete.

3

### CLEANING AND CARE

Clean surfaces with a dry or damp soft cloth. Do not use abrasive cleaners. Do not use furniture wax or polish as the unit is finished with a protective clear lacquer.