

Thank you for purchasing the **Facet Bookcase**. This page lists all the contents included in the box. Please take the time to identify the hardware as well as the individual components to this product. As you unpack and prepare for assembly, place the contents on a carpeted or padded area to protect them from damage.

Note: 2 people are recommended to safely assemble this product.

## assembly hardware



24 - wood dowels



24 - bolts



24 - flat washers



24 - spring washers

## wall mounting hardware

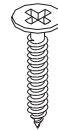

2 - large screws



2 - small screws



2 - plastic anchors



2 - wall straps



4 - mounting brackets

Missing hardware?

Please call **800.606.6387** for replacements.

## tools required

allen wrench (included)



Phillips head screwdriver

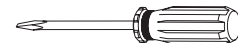

(We recommend the use of hand tools instead of power tools)

## components

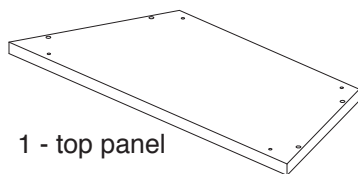

1 - top panel

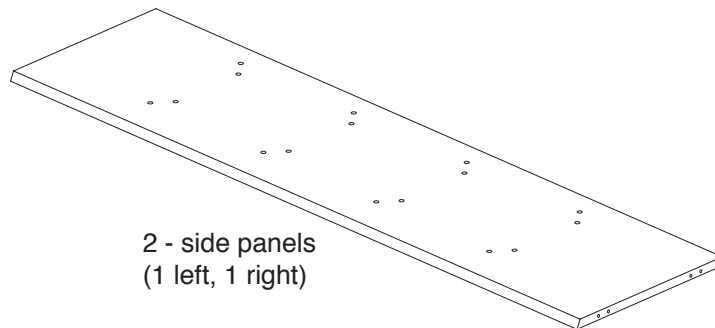

2 - side panels  
(1 left, 1 right)

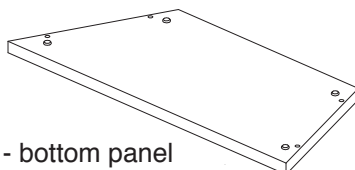

1 - bottom panel

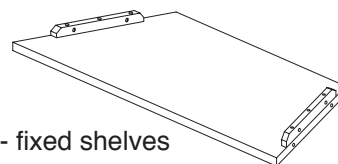

4 - fixed shelves

left and right side panel X 2

**1** Insert 12 **wood dowels** into **right and left side panels** as shown.

NOTE: Do not over tighten the bolts

fixed shelf

left side panel

**2** Fit 4 **fixed shelves** onto corresponding dowels of **left side panel**. Using an **allen wrench**, secure but do not over tighten with 8 **bolts**, 8 **spring washers** and 8 **flat washers** as shown.

right side panel

NOTE: During assembly make sure the angle at the front of the shelf is the same angle as the side panel it attaches to.

**3** Fit 4 **fixed shelves** onto corresponding dowels of **right side panel**, and secure with 8 **bolts**, 8 **spring washers** and 8 **flat washers** as shown.

top panel

**4** Fit **top panel** onto dowels of assembly and secure with 4 **bolts**, 4 **spring washers** and 4 **flat washers** as shown.

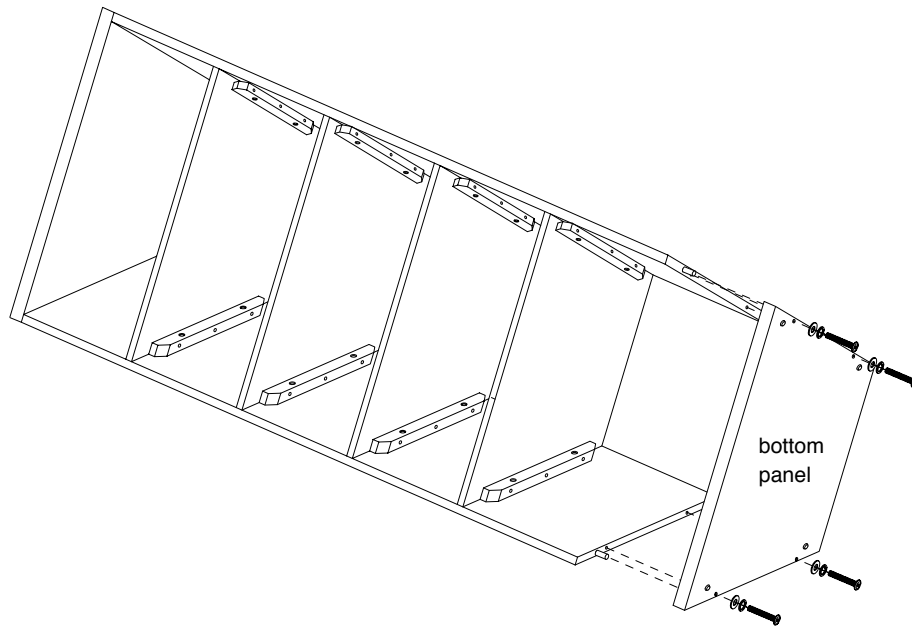

Fit **bottom panel** onto dowels of assembly and secure with 4 **bolts**, 4 **spring washers** and 4 **flat washers** as shown. With the assistance of another adult, carefully position unit upright. Assembly is now complete.

5

### CLEANING AND CARE

Clean surfaces with a dry or damp soft cloth.  
Do not use abrasive cleaners.

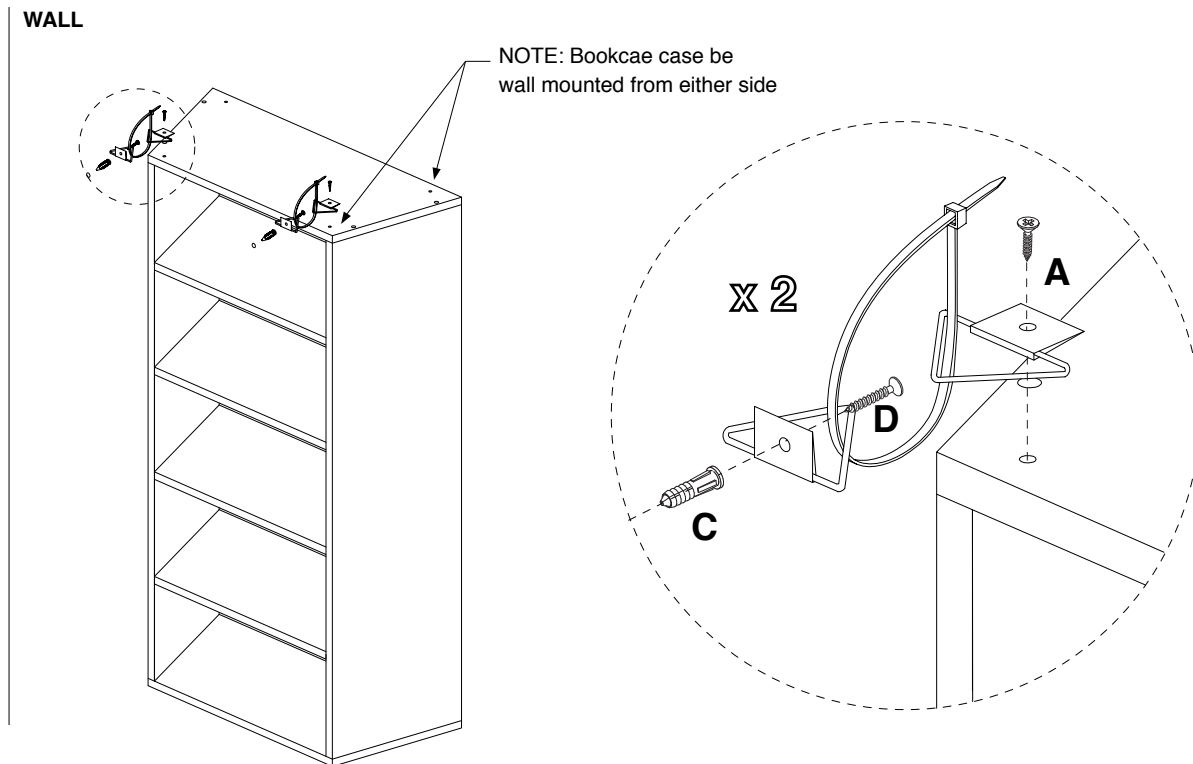

For added safety and stability, it is recommended that the wall mounting hardware be installed. For safe mounting, it is essential to use wall anchors appropriate to your wall type (i.e. plaster, drywall, concrete, etc.). Mount to wood studs whenever possible.

- A) Attach 2 **mounting brackets** to top of unit using 1 **small screw** per bracket.
- B) Determine the final location of unit. Mark position on the wall, approximately 2" below each mounting brackets mounted to the back of the unit.
- C) Drill a hole in the wall stud. If the wall stud is not available, drill a hole in the wall that is slightly smaller in diameter than the anchor. Gently tap the **plastic anchor** until the flange of the anchor is flush with the wall.
- D) Attach the **mounting brackets** to the wall by inserting 1 **large screw** through each mounting bracket and into the wall anchor in the wall.
- E) Position the unit so the mounting bracket on the back edge is allowed with the wall bracket.
- F) Lace one end of each **wall strap** through corresponding brackets, and into the other end of the strap.
- G) Pull the straps tightly until secure.

**NOTE:**

**If you are unsure about your wall type or what mounting method you should use, consult a qualified professional or your local hardware store.**

Wall mounting assembly is now complete.