

Thank you for purchasing the **Dwight 5-Shelf Bookcase**. This page lists all the contents included in the box. Please take the time to identify the hardware as well as the individual components to this product. As you unpack and prepare for assembly, place the contents on a carpeted or padded area to protect them from damage.

Note: 2 people are required to safely assemble this product.

assembly hardware

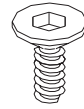

24 - bolts

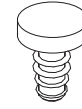

4 - levelers



20 - glass bumpers

wall mounting hardware

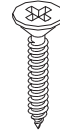

2 - large screws



2 - plastic anchors

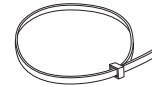

2 - wall straps



4 - wall brackets

Missing hardware?

Please call **800.606.6387** for replacements.

tools required

phillips head screwdriver

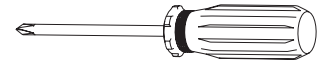

allen wrench (included)



(We recommend the use of hand tools instead of power tools)

components

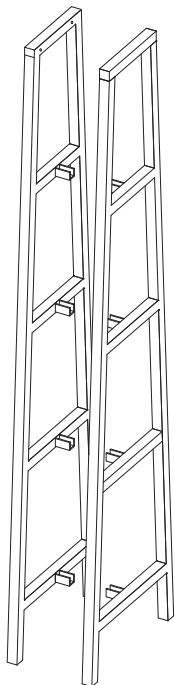

2 - side frames
(1 left, 1 right)

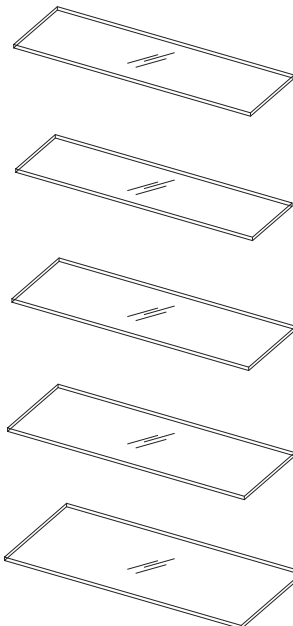

5 - glass shelves
(shown in order of
smallest to largest)

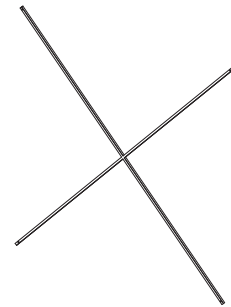

1 - crossbrace

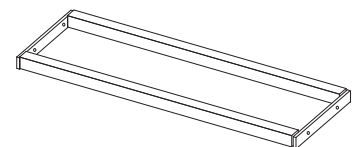

1 - top frame

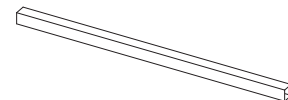

4 - crossbars

NOTE: Make sure pilot holes in crossbars are positioned towards the bottom during assembly

top frame

crossbar

left side frame

A X 2

B X 4

NOTE: Do not fully tighten bolts

1

A. Place **left side frame** on a clean, padded surface. Attach **top frame** to **left side frame** with 2 **bolts** as shown, using an **allen wrench**. Do not fully tighten the bolts until further instructions.

B. Fit 4 **crossbars** onto corresponding brackets of **left side frame**. Secure each crossbar with 2 **bolts** as shown. Do not fully tighten the bolts.

NOTE: Make sure pilot holes in side frames are positioned towards the back during assembly

right side frame

left side frame

A X 2

B X 4

NOTE: Do not fully tighten bolts

2

A. Attach **top frame** to **right side frame** with 2 **bolts** as shown. Do not fully tighten the bolts.

B. Fit 4 **crossbars** onto corresponding brackets of **right side frame**. Secure each crossbar with 2 **bolts** as shown. Do not fully tighten the bolts.

C. Insert 2 **levelers** to bottom of each **side frame** as shown. Turn levelers clockwise to secure.

BACK VIEW OF ASSEMBLY

NOTE: Do not over tighten bolts

cross brace

A

B

3

A. With assistance of another adult, carefully position bookcase upright. Attach **cross brace** to back of bookcase with 4 **bolts** as shown.

B. At this point, secure all **bolts** with an **allen wrench**. Do not over tighten the bolts.

TOP glass shelf

glass bumper

smallest glass shelf

largest glass shelf

NOTE: Make sure each shelf is securely supported by each glass bumper

A

B

4

A. Adhere 4 **glass bumpers** per shelf as shown.

B. Carefully place **glass shelf (labeled TOP)** onto top of bookcase and **smallest to largest glass shelves** onto remaining shelves as shown. Adjust **levelers** as necessary. Assembly is now complete.

wall mounting assembly

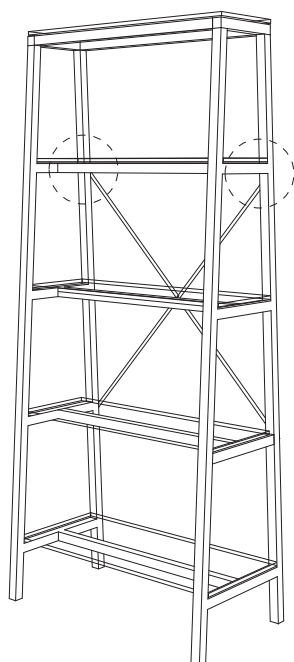
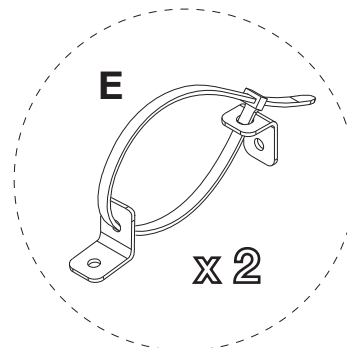
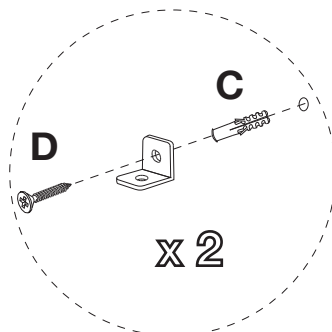
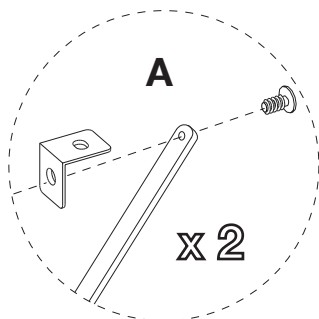

WALL

These instructions are for drywall mounting only. For safe installation it is essential to use hardware appropriate for your wall type. Mount to wood wall studs whenever possible. If you are unsure of what type of fasteners to use, consult your local hardware store or a qualified professional. This product is only deterrent, it is not a substitute for proper adult supervision.

A. With an **allen wrench**, remove top 2 **bolts** from **crossbrace** as shown. At this point, re-attach crossbrace and 2 **wall brackets** with 2 **bolts**.

B. With the assistance of another adult, place the unit in desired location against the wall. Mark the location of the hole in the bracket on the wall. Move the unit out of the workspace.

C. Drill holes slightly smaller in diameter than the drywall anchors. Insert 1 **plastic anchor** into each hole until they are flush to the wall.

D. Insert 1 **screw** through each **wall bracket** and into the plastic anchor. Secure, but do not over tighten with a **phillips head screwdriver**.

E. Place the bookcase back into position against the wall and thread the **wall strap** through both brackets and pull until tight. Wall mounting is now complete.

cleaning and care

Clean surfaces with a dry or damp soft cloth. Do not use abrasive cleaners.

weight limitations

1st (labeled TOP) shelf: 20lbs max; 2nd (smallest) shelf: 19lbs max; 3rd shelf: 22lbs max; 4th shelf: 26lbs; 5th (largest) shelf: 29lb max