

This page lists the contents included in the box. Please take time to identify the hardware as well as the individual components of the product. As you unpack and prepare for assembly, place the contents on a carpeted or padded area to protect them from damage. Please follow the assembly instructions closely. Improper assembly can result in personal or property damage.

This portable lamp has a polarized plug (one blade is wider than the other) as a safety feature to reduce the risk of electric shock. This plug will fit in a polarized outlet only one way. If the plug does not fit fully in the outlet, reverse the plug. If it still does not fit, contact a qualified electrician. Never use with an extension cord unless plug can be fully inserted. **Do not attempt to override this safety feature.**

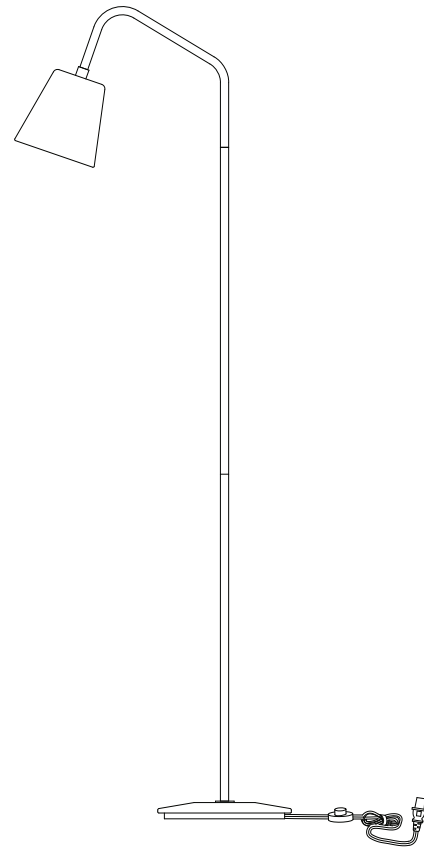
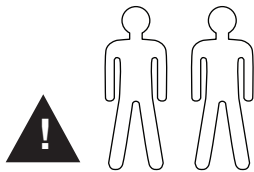

hardware & components

800.606.6387

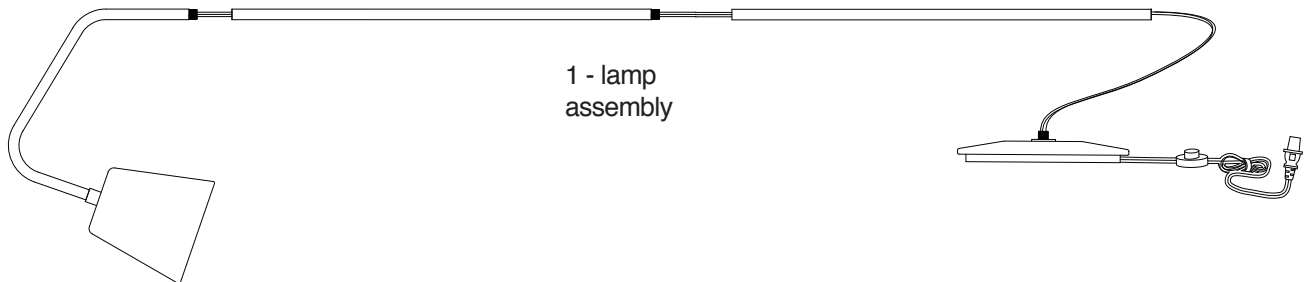

1 - lamp assembly



1 - E12 13 watt max CFL bulb (INCLUDED)



1 - E12 40 watt max type B bulb (NOT INCLUDED)

cleaning & care

Dust surfaces with a dry soft cloth. Do not use polishes or cleaners on the lamp.

crane FLOOR LAMP



1

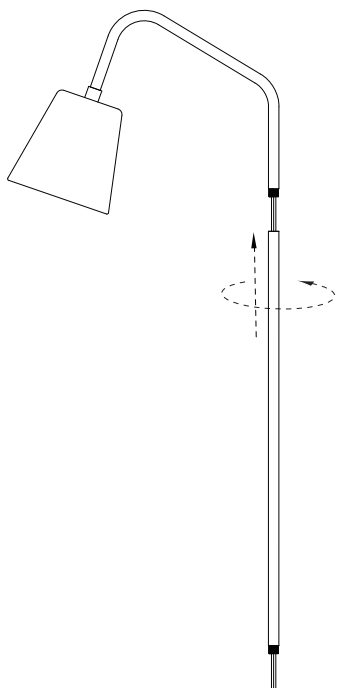

Fit threaded end of *top upright* into assembly as shown. Turn counter-clockwise to secure.

2

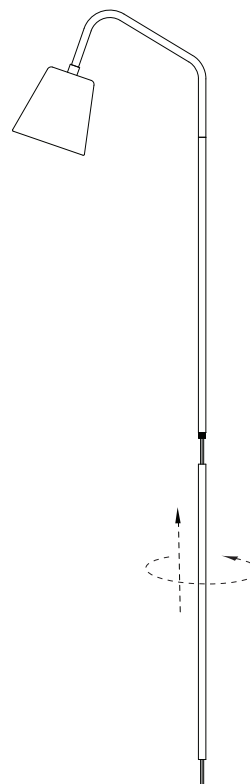

Fit threaded end of *bottom upright* into assembly and turn counter-clockwise to secure.

3

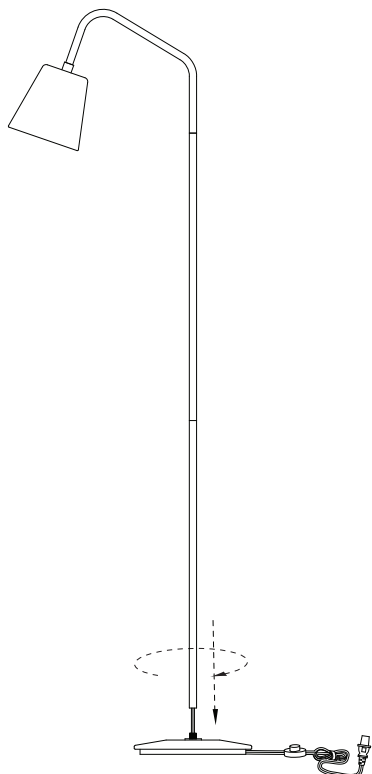

Fit threaded end of *lower upright* into base as shown. Turn clockwise to secure.

4

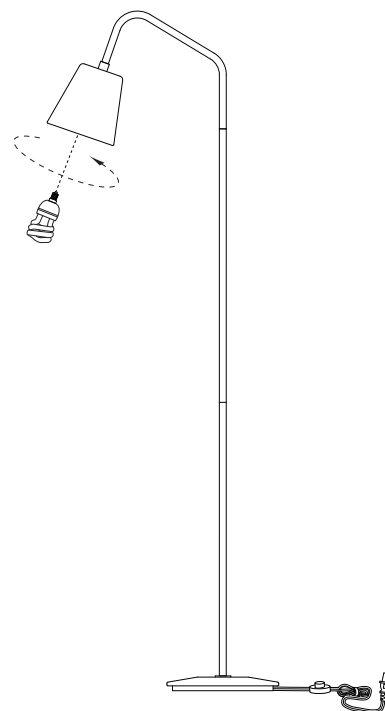

Fit **bulb** into socket as shown. **DO NOT EXCEED SPECIFIED WATTAGE.**

Assembly is now complete.