

Thank you for purchasing the **Buzz C Table**. This page lists all the contents included in the box. Please take time to identify the hardware as well as the individual components of this product. As you unpack and prepare for assembly, place the contents on a carpeted or padded area to protect them from damage.

## hardware



9 - wood dowels



4 - cam screws



4 - bolts



4 - flat washers



4 - barrel nuts



4 - spring washers



4 - cams

Missing hardware? Please call **800.606.6387** for replacements.

## tools required

Flat Head Screwdriver

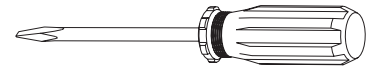

Phillips Head Screwdriver

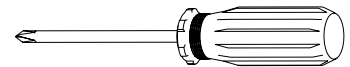

## components

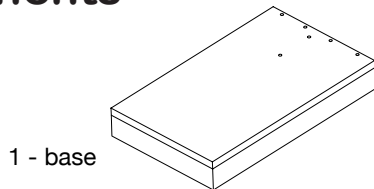

1 - base

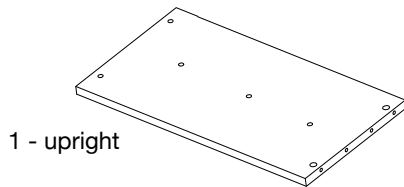

1 - upright

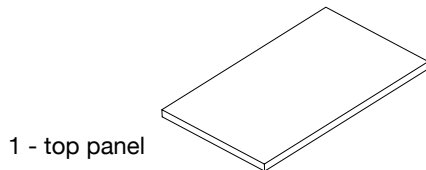

1 - top panel

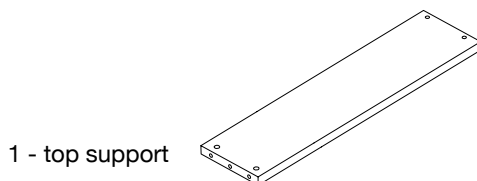

1 - top support

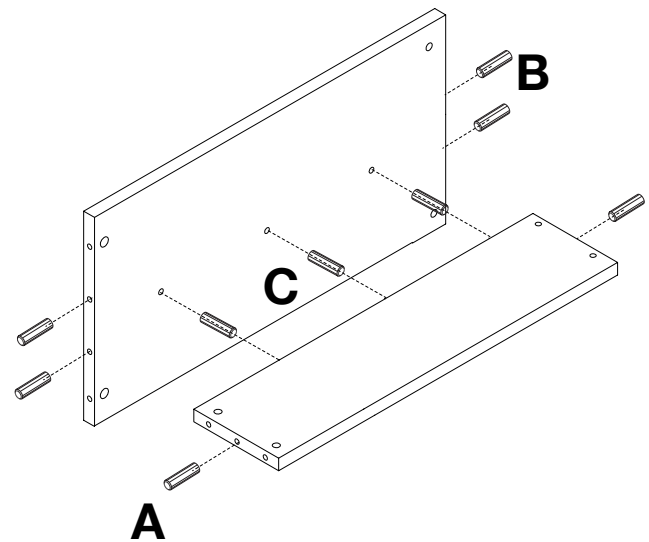

A) Insert 2 **wood dowels** into the ends of the **top support** as shown.

B) Insert 7 **wood dowels** into the **upright**.

C) Fit top support onto dowels of upright and firmly press together.

**1**

Use screwdriver to align hole in the barrel nut with hole in edge of panel

**2** Insert 4 **barrel nuts** into the upright assembly. Using a **flat head screwdriver**, align the hole in the barrel nut with the corresponding hole in the edge of the panels.

Use screwdriver to align hole with bolt

**x4**

**3** Insert 4 **bolts**, 4 **spring washers**, and 4 **flat washers** through the **base** and into the barrel nuts of the upright assembly. Fully tighten each bolt with a **phillips head screwdriver**.

**A**

**B**

**4** A) Insert 4 **cam screws** into the **top panel** as shown. Secure, but do not over tighten with a **phillips head screwdriver**.  
B) Insert 4 **cams** into the upright and top support. Make sure the arrow on each cam points towards the nearest edge with holes.

Cam in unlocked position

Cam in locked position

**5** Fit cam screws of **top panel** into corresponding holes in the upright assembly. Secure the top to the assembly by turning all 4 **cams** clockwise with a **phillips head screwdriver** until each cam securely engages each cam screw. Assembly is now complete.

**CLEANING AND CARE**

Clean surfaces with a dry or damp soft cloth. Do not use abrasive cleaners. Do not use furniture wax or polish as the unit is finished with a protective clear lacquer.