

Thank you for purchasing the **Bauhaus Table Lamp**. This page lists all the contents included in the box. Please take the time to identify the hardware as well as the individual components to this product. As you unpack and prepare for assembly, place the contents on a carpeted or padded area to protect them from damage.

## components

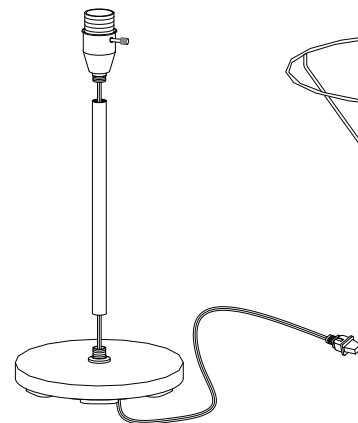

## assembly

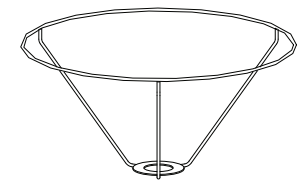
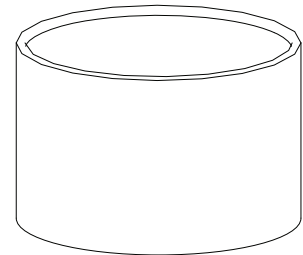
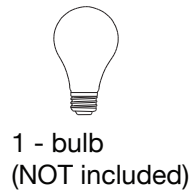
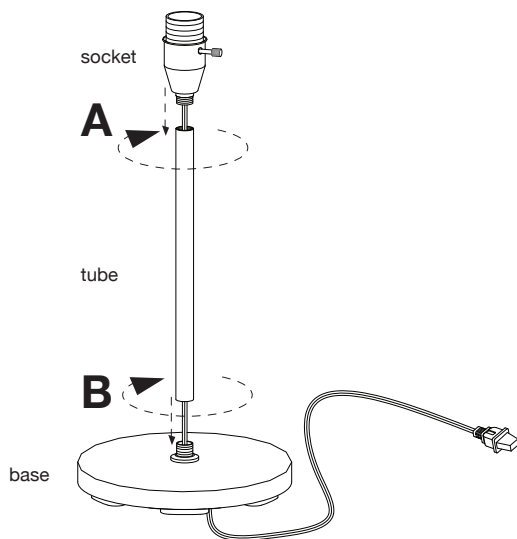

Carefully remove all components from box, remove all plastic coverings. Place **base unit** upright onto clean, padded surface.

- 1 A. Assemble **socket** to **tube**.
- B. Assemble **tube** to **base unit**.

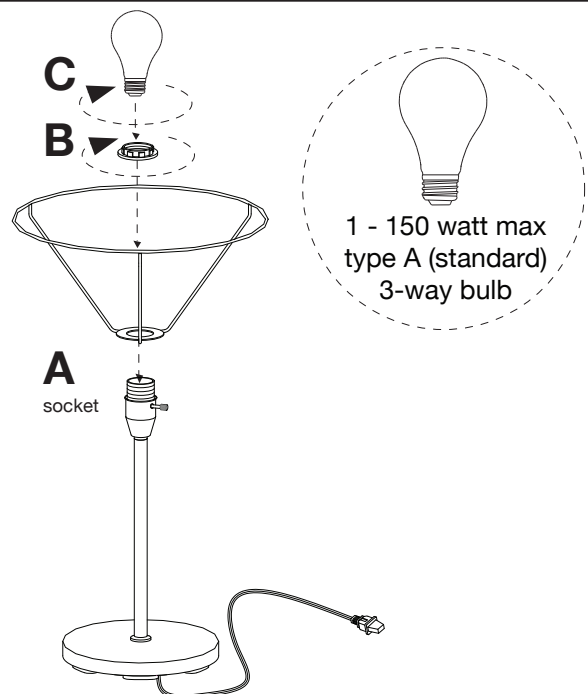

- 2 A. Place **lampshade bracket** onto the socket.
- B. Secure by fastening **socket ring** to threaded socket.
- C. Install 1 - **150 watt max type A 3-way bulb** into socket.

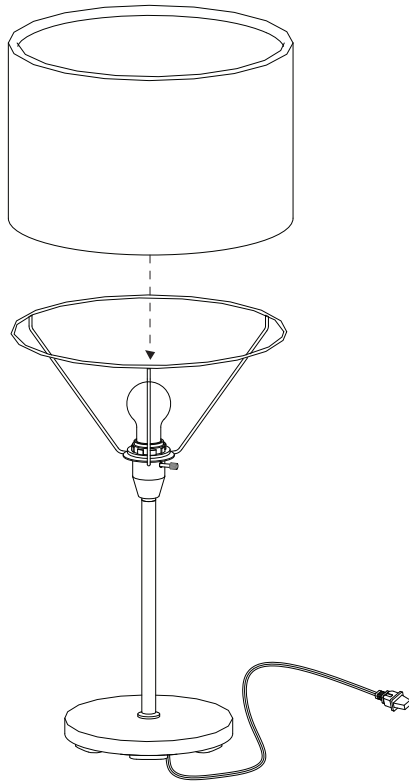

**3**

Place **shade** on the **lampshade bracket**.

Assembly is now complete.

### **cleaning & care**

Do not use polishes or cleaners on your lamp. Dust surfaces with a dry soft cloth.

#### **IMPORTANT SAFETY INSTRUCTIONS:**

This portable lamp has a polarized plug (one blade is wider than the other) as a safety feature to reduce the risk of electric shock. This plug will fit in a polarized outlet only one way. If the plug does not fit fully in the outlet, reverse the plug. If it still does not fit, contact a qualified electrician. Never use with an extension cord unless plug can be fully inserted. Do not attempt to override this safety feature.